

15 mm Polyester Tül				
Uzunluk	Tepe sayısı	Birim	1 Paket m2	1 Koli 5 Paket
2.00 mt	840.00	Paket	50	250
2.20 mt	840.00	Paket	55	275
2.40 mt	840.00	Paket	60	300
2.70 mt	840.00	Paket	68	340
3.00 mt	840.00	Paket	75	375

17 mm Polyester Tül				
Uzunluk	Tepe sayısı	Birim	1 Paket m2	1 Koli 5 Paket
2.00 mt	736.00	Paket	50	250
2.20 mt	804.00	Paket	60	300
2.40 mt	732.00	Paket	60	300
2.70 mt	764.00	Paket	70	350
3.00 mt	790.00	Paket	80	400

19 mm Polyester Tül				
Uzunluk	Tepe sayısı	Birim	1 Paket m2	1 Koli 5 Paket
2.00 mt	790.00	Paket	60	300
2.20 mt	720.00	Paket	60	300
2.40 mt	660.00	Paket	60	300
2.70 mt	684.00	Paket	70	350
3.00 mt	706.00	Paket	80	400

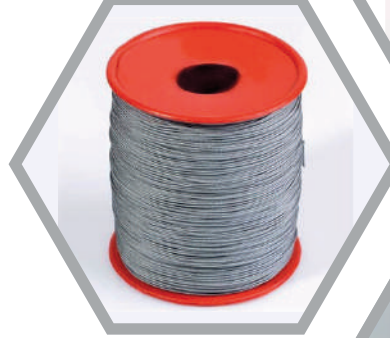

SİNEKLİK PROFİLLERİ

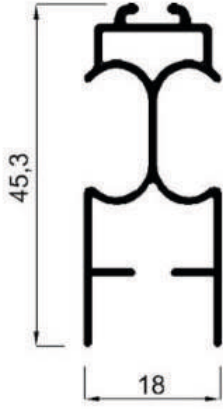

18'lik Seri

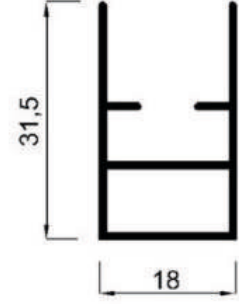

8452 - 0,341 kg/m

8453 - 0,222 kg/m

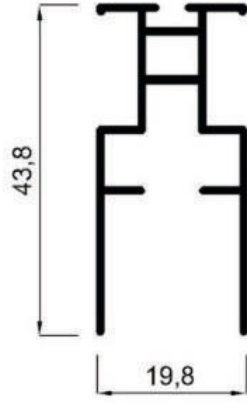

30'luk Seri

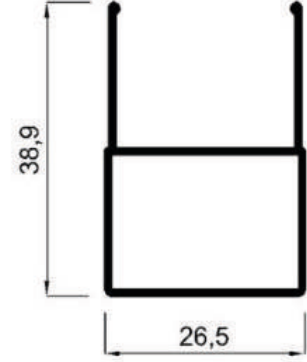

8484 - 0,306 kg/m

8465 - 0,285 kg/m

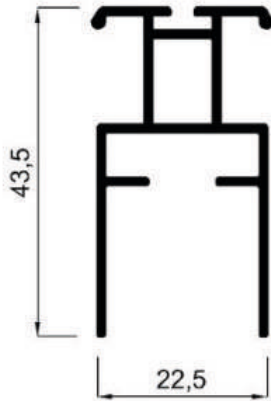

8281 - 0,404 kg/m

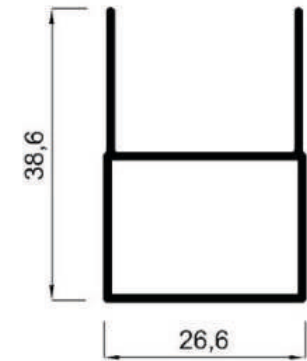

8798 - 0,276 kg/m

SİNEKLİK PROFİLLERİ

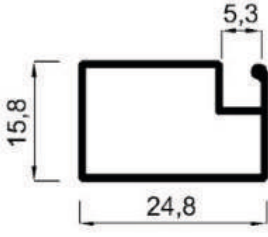

17x25 Seri

5562 - 0,165 kg/m

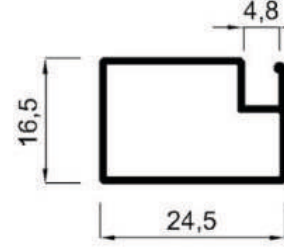

6200 - 0,153 kg/m

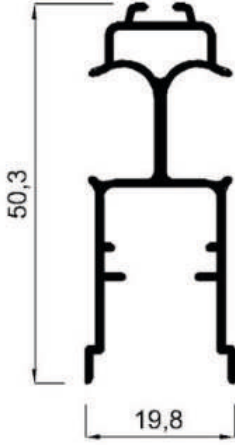

7253 - 0,370 kg/m

18'lik Seri

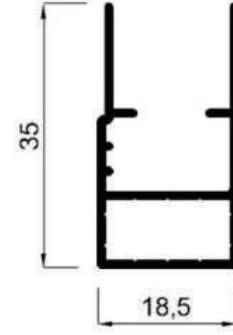

7254 - 0,272 kg/m

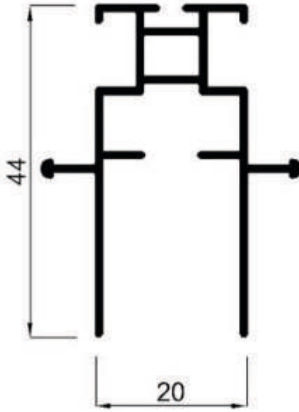

8365 - 0,352 kg/m

35'lik Seri

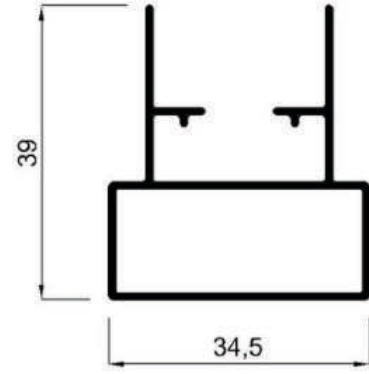

8364 - 0,349 kg/m

DUŞAKABİN SİSTEMLERİ

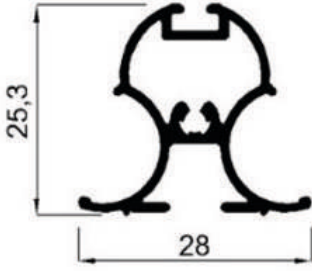

3815 - 0,292 kg/m

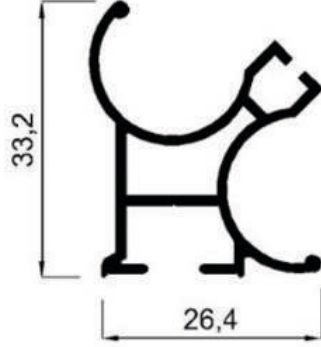

3825 - 0,353 kg/m

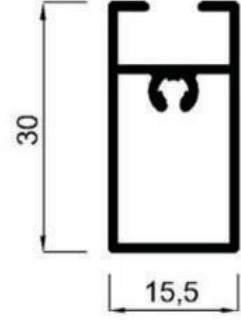

3826 - 0,267 kg/m

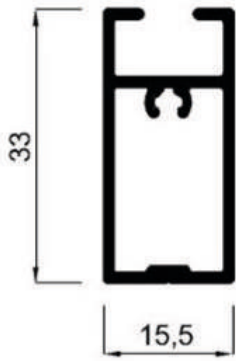

4183 - 0,345 kg/m

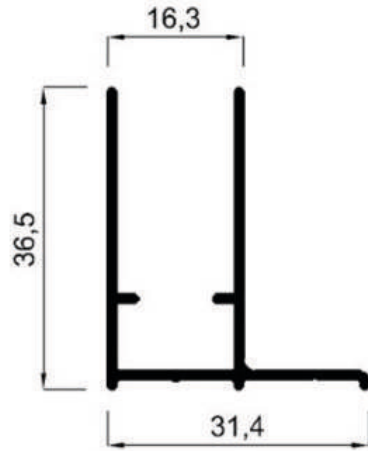

4172 - 0,296 kg/m

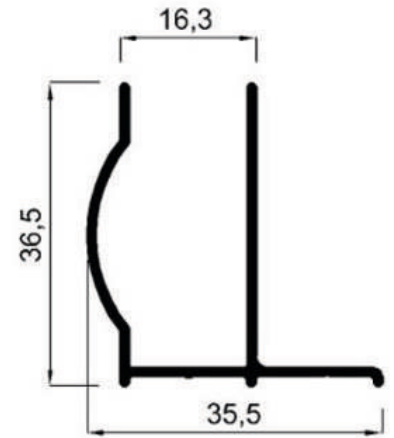

4173 - 0,286 kg/m

DUŐAKABİN SİSTEMLERİ

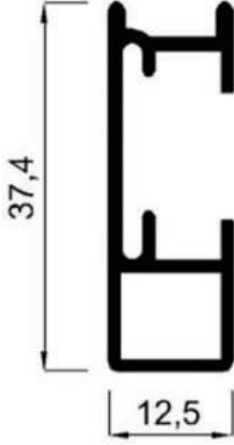

4177 - 0,301 kg/m

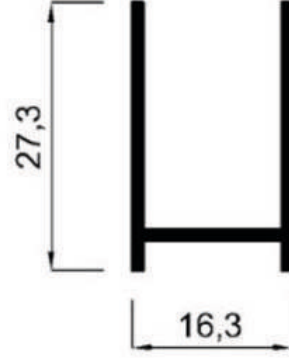

4185 - 0,205 kg/m

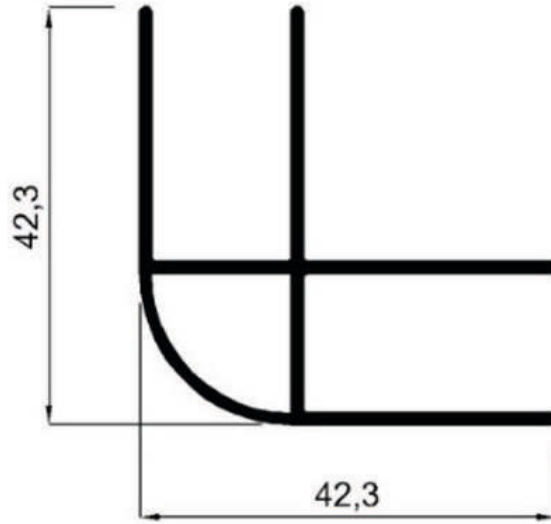

4510 - 0,473 kg/m

DUŞAKABİN SİSTEMLERİ

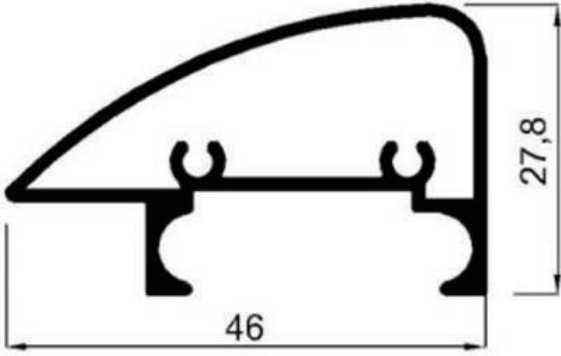

8278 - 0,458 kg/m

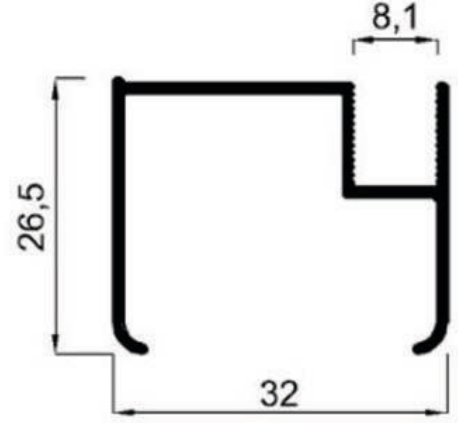

8279 - 0,241 kg/m

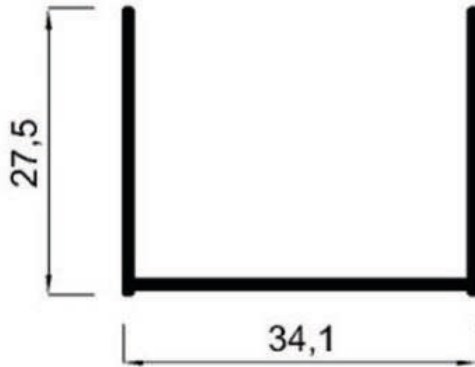

8280 - 0,225 kg/m

DUŞAKABİN SİSTEMLERİ

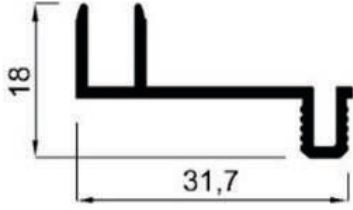

8052 - 0,193 kg/m

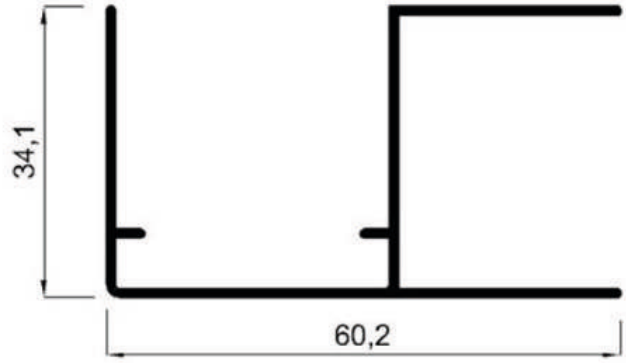

8053 - 0,409 kg/m

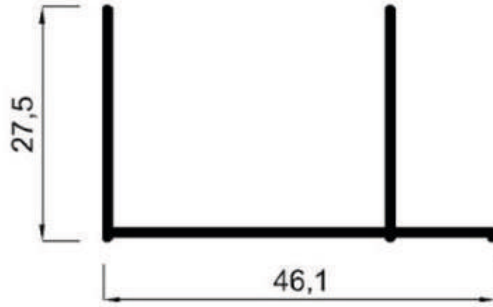

8054 - 0,257 kg/m

DUŞAKABİN SİSTEMLERİ

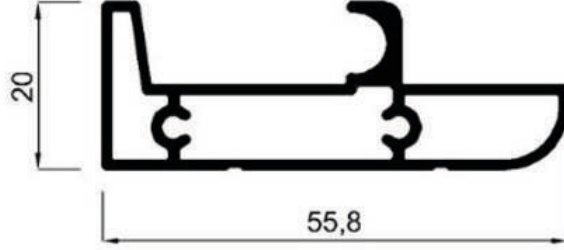

7164 - 0,543 kg/m

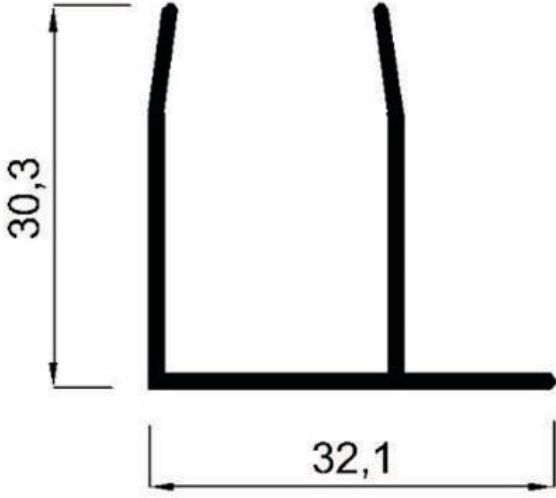

7165 - 0,413 kg/m

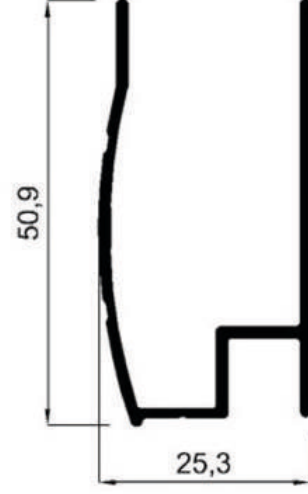

7166 - 0,246 kg/m

DUŞAKABİN SİSTEMLERİ

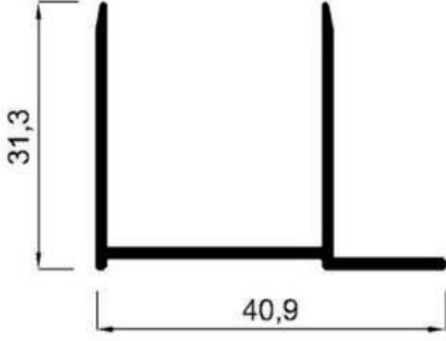

7167 - 0,284 kg/m

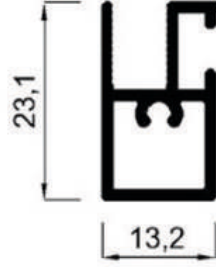

7168 - 0,247 kg/m

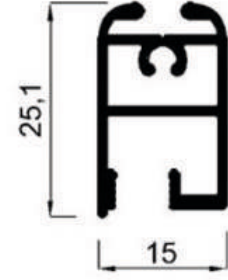

7169 - 0,283 kg/m



7170 - 0,442 kg/m

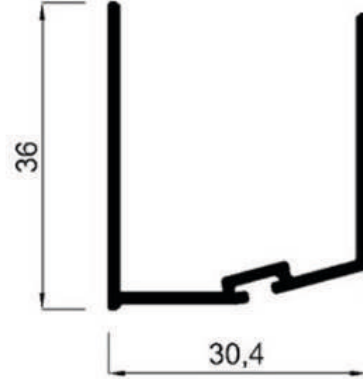

7255 - 0,328 kg/m

DUŞAKABİN SİSTEMLERİ

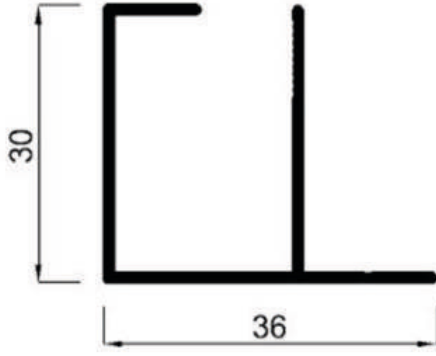

7171 - 0,277 kg/m

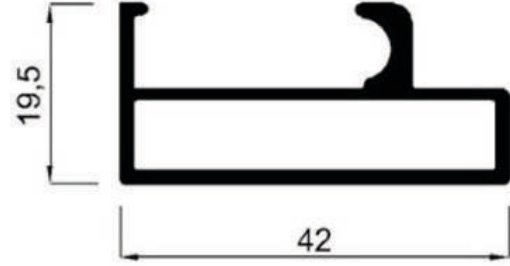

7172 - 0,450 kg/m

DUŞAKABİN SİSTEMLERİ

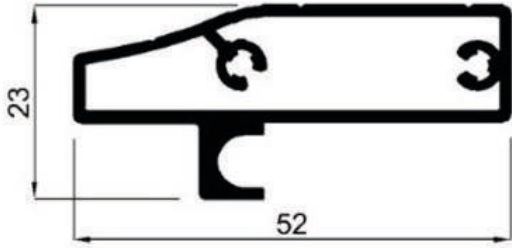

1750 - 0,596 kg/m

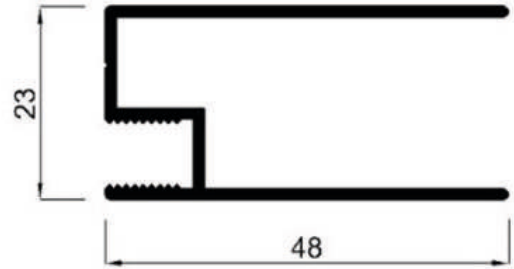

1751 - 0,423 kg/m

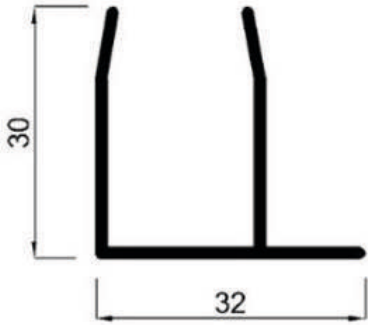

1752 - 0,290 kg/m

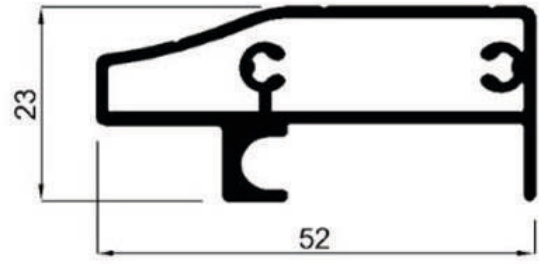

8125 - 0,625 kg/m

DUŞAKABİN SİSTEMLERİ

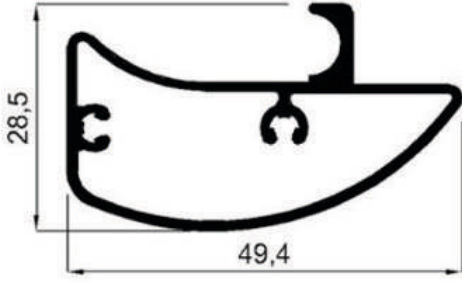

4452 - 0,512 kg/m

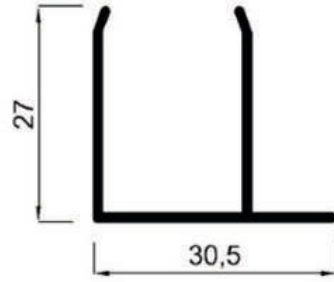

4453 - 0,223 kg/m

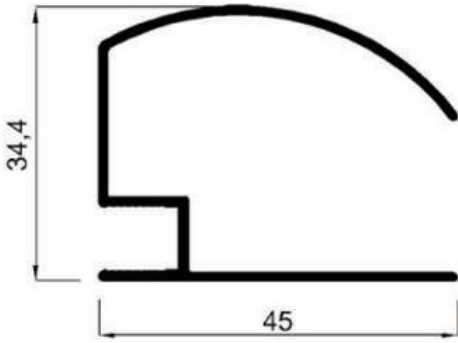

4454 - 0,368 kg/m

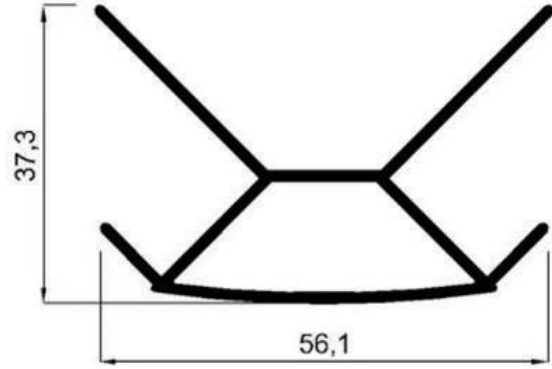

4455 - 0,564 kg/m

DUŞAKABİN SİSTEMLERİ

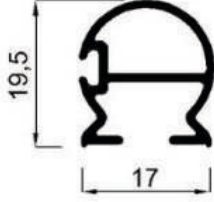

3807 - 0,198 kg/m

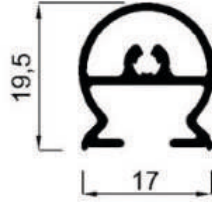

3809 - 0,221 kg/m

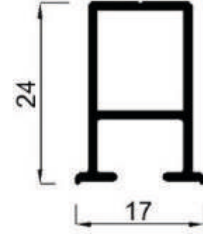

3810 - 0,194 kg/m

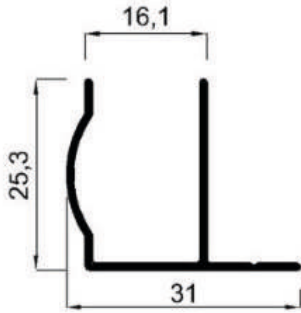

3811 - 0,190 kg/m

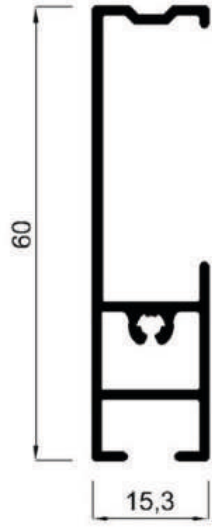

3813 - 0,428 kg/m

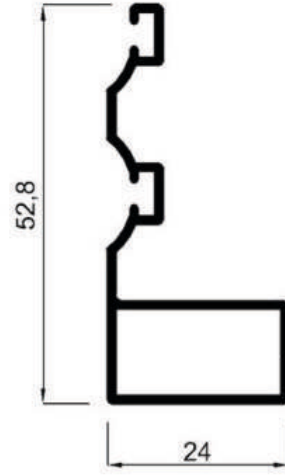

3814 - 0,359 kg/m

CAM BALKON SİSTEMLERİ

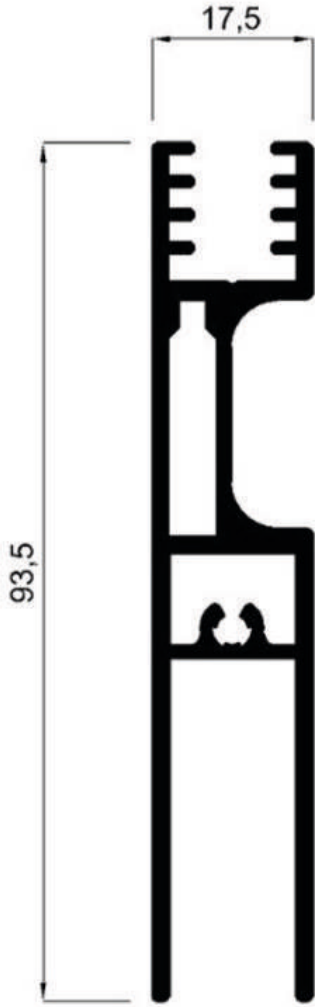

7213- 1,247 kg/m

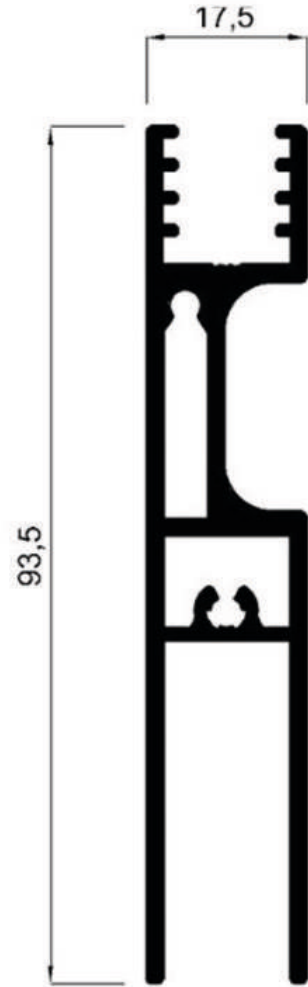

7212- 1,259 kg/m

CAM BALKON SİSTEMLERİ

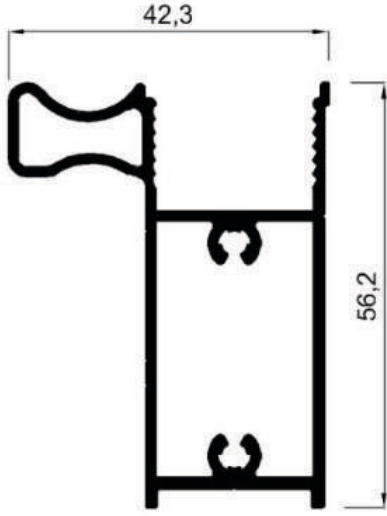

7192 - 0,807 kg/m

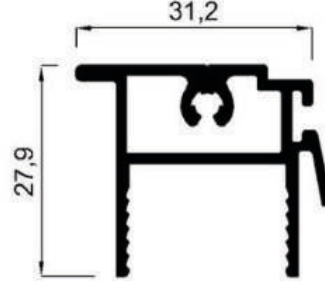

7193 - 0,477 kg/m

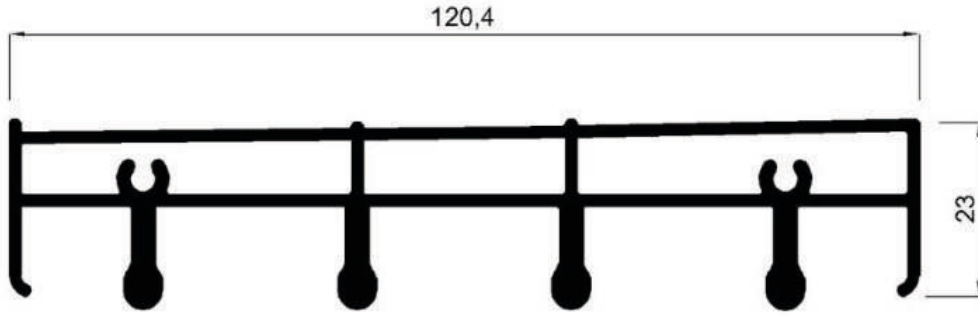

7194 - 1,759 kg/m

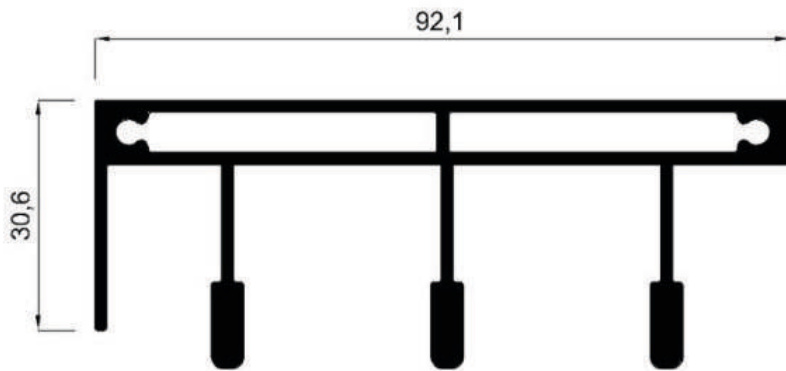

7195 - 1,630 kg/m

CAM BALKON SİSTEMLERİ

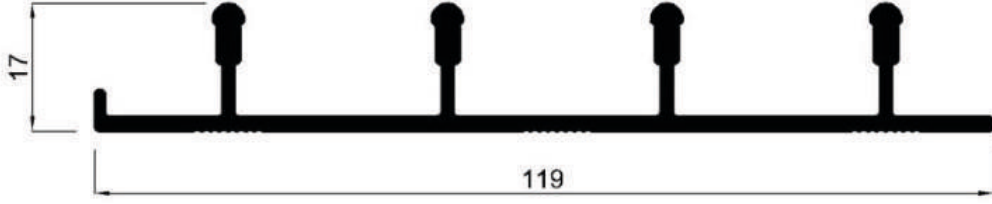

7176 - 1,057 kg/m

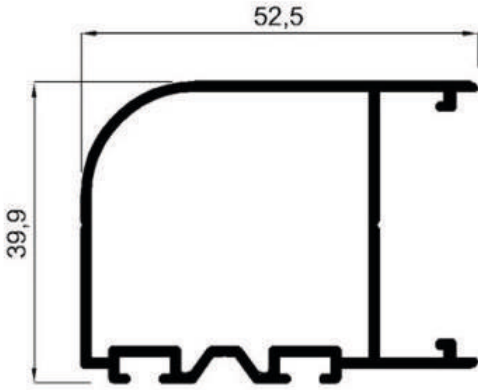

7177 - 0,648 kg/m

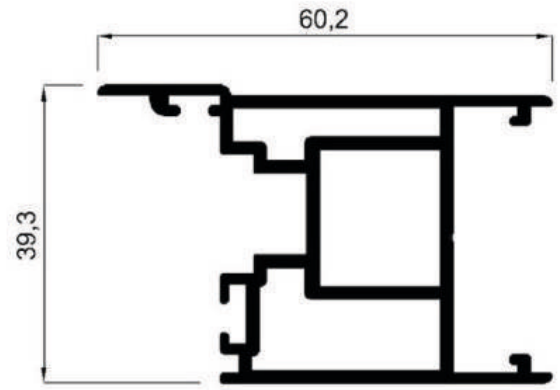

7178 - 1,003 kg/m

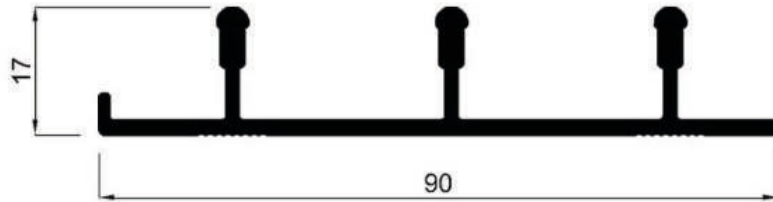

7179 - 0,779 kg/m

CAM BALKON SİSTEMLERİ

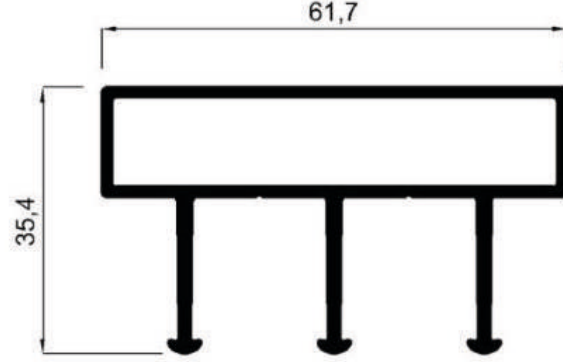

7211 - 0,900 kg/m

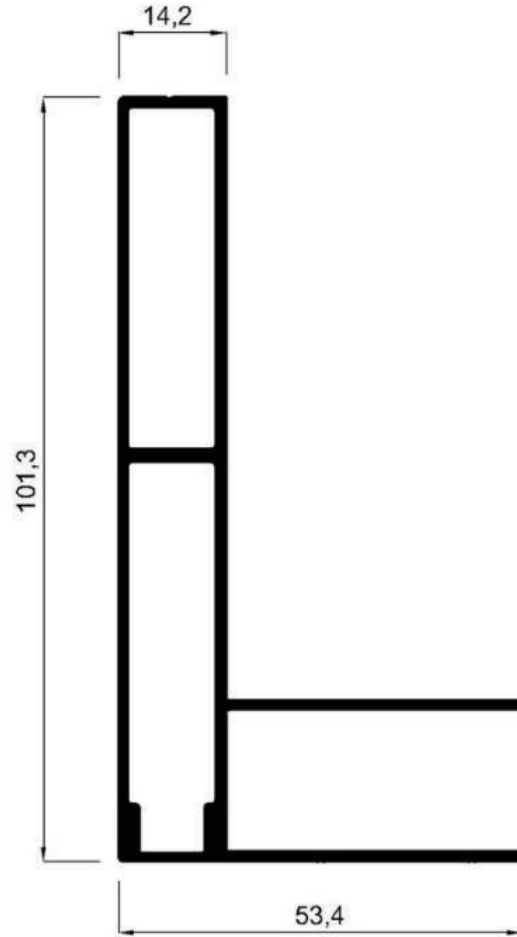

7214 - 1,181 kg/m

CAM BALKON SİSTEMLERİ

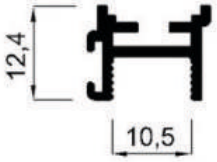

7215 - 0,155 kg/m

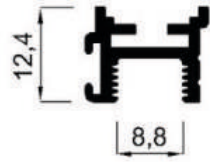

7216 - 0,172 kg/m

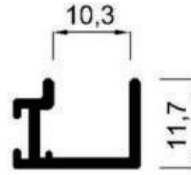

7217 - 0,140 kg/m

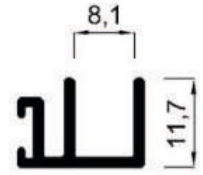

7218 - 0,159 kg/m

CAM BALKON SİSTEMLERİ

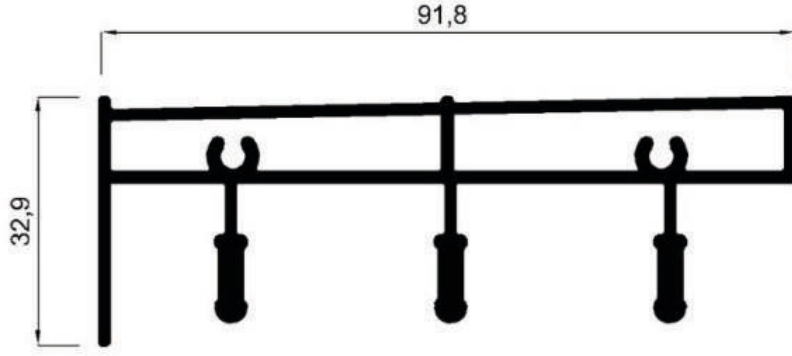

7196 - 1,366 kg/m

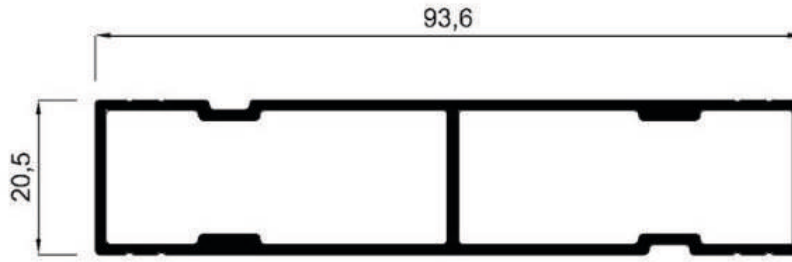

7197 - 0,961 kg/m

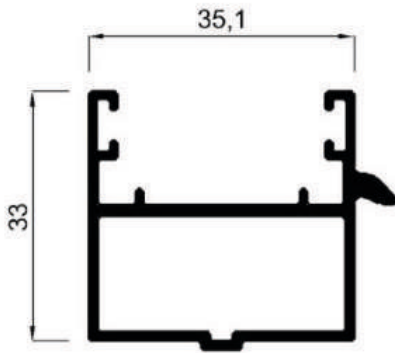

7198 - 0,554 kg/m

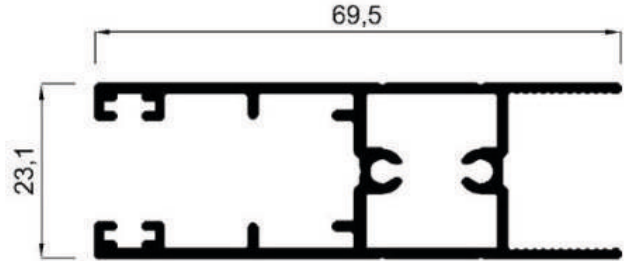

7199 - 0,765 kg/m

CAM BALKON SİSTEMLERİ

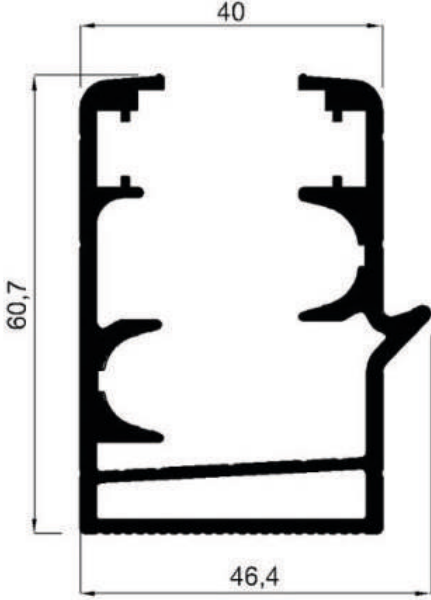

7180 - 1,482 kg/m

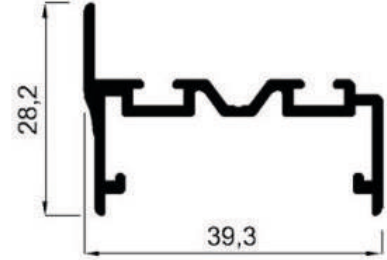

7181 - 0,374 kg/m

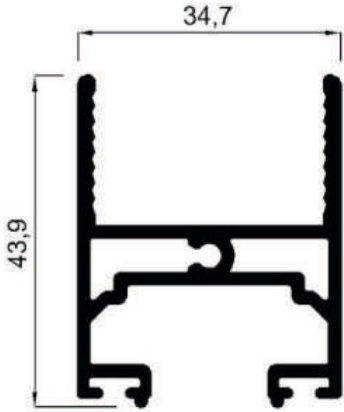

7182 - 0,837 kg/m

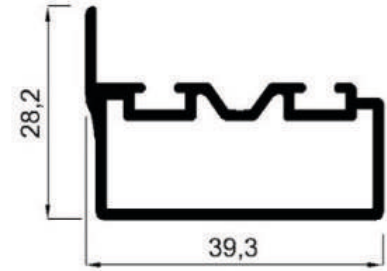

7183 - 0,463 kg/m

CAM BALKON SİSTEMLERİ

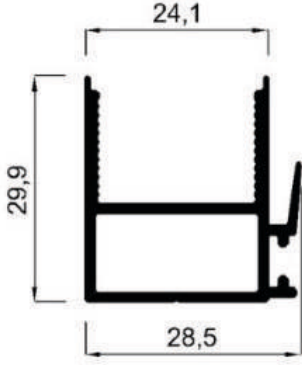

7200 - 0,417 kg/m

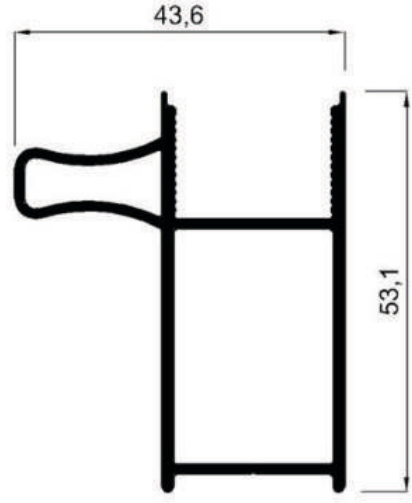

7201 - 0,701 kg/m

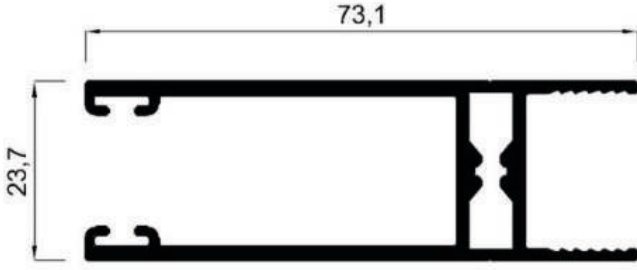

7202 - 0,927 kg/m

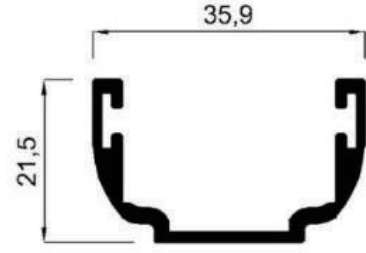

7203 - 0,365 kg/m

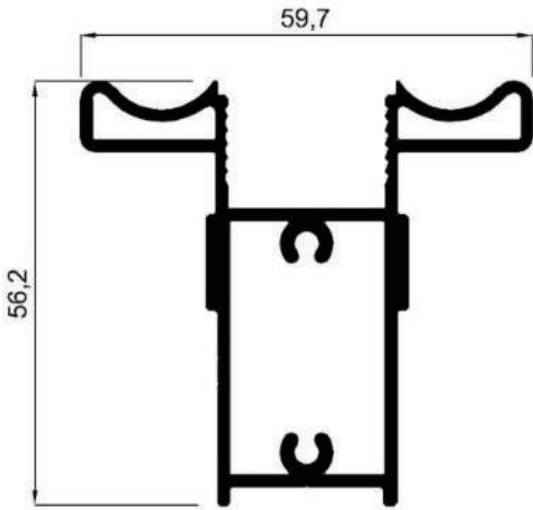

7205 - 1,113 kg/m

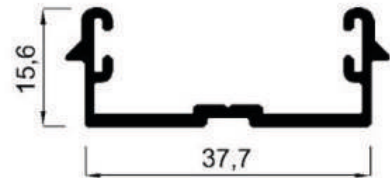

7204 - 0,314 kg/m

CAM BALKON SİSTEMLERİ

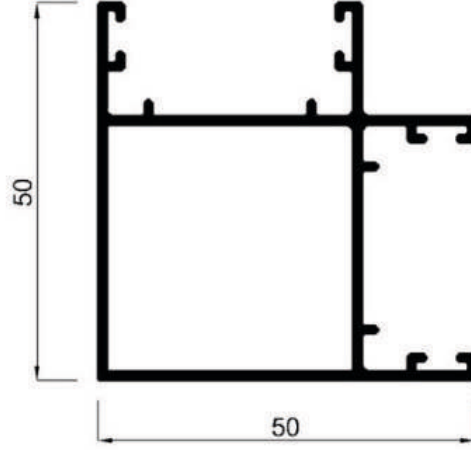

7184 - 0,743 kg/m

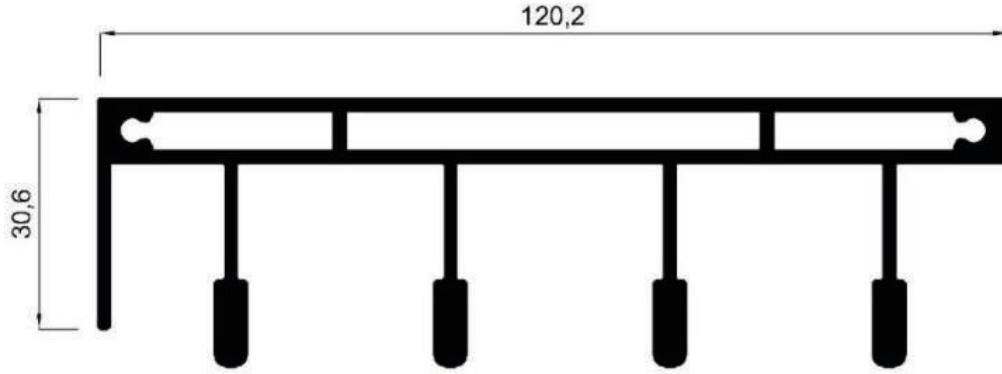

7185 - 2,093 kg/m

CAM BALKON SİSTEMLERİ

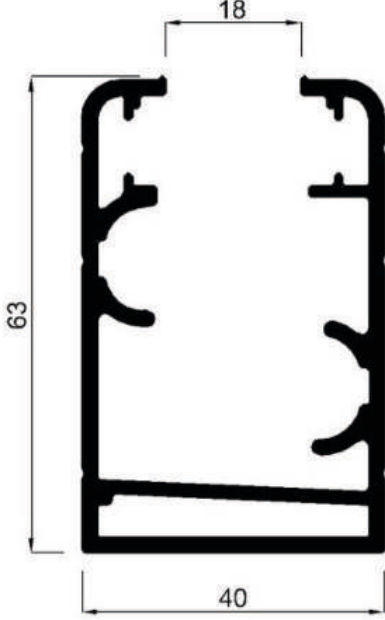

7100 - 1,404 kg/m

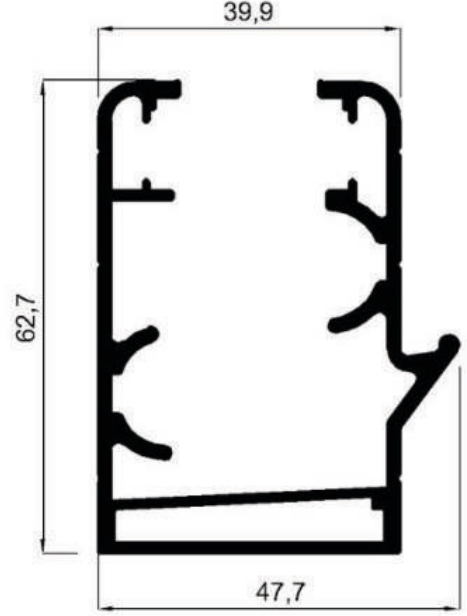

7101 - 1,284 kg/m

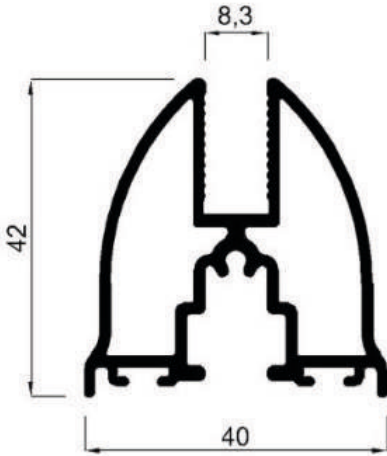

7102 - 0,816 kg/m

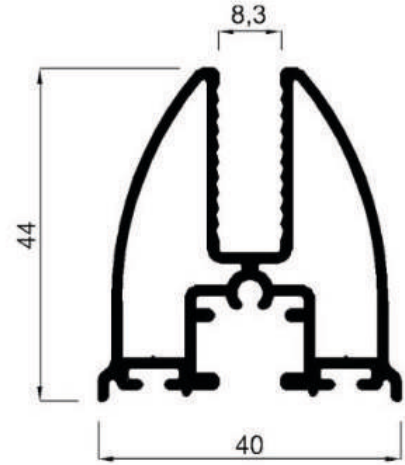

7107 - 0,840 kg/m

CAM BALKON SİSTEMLERİ

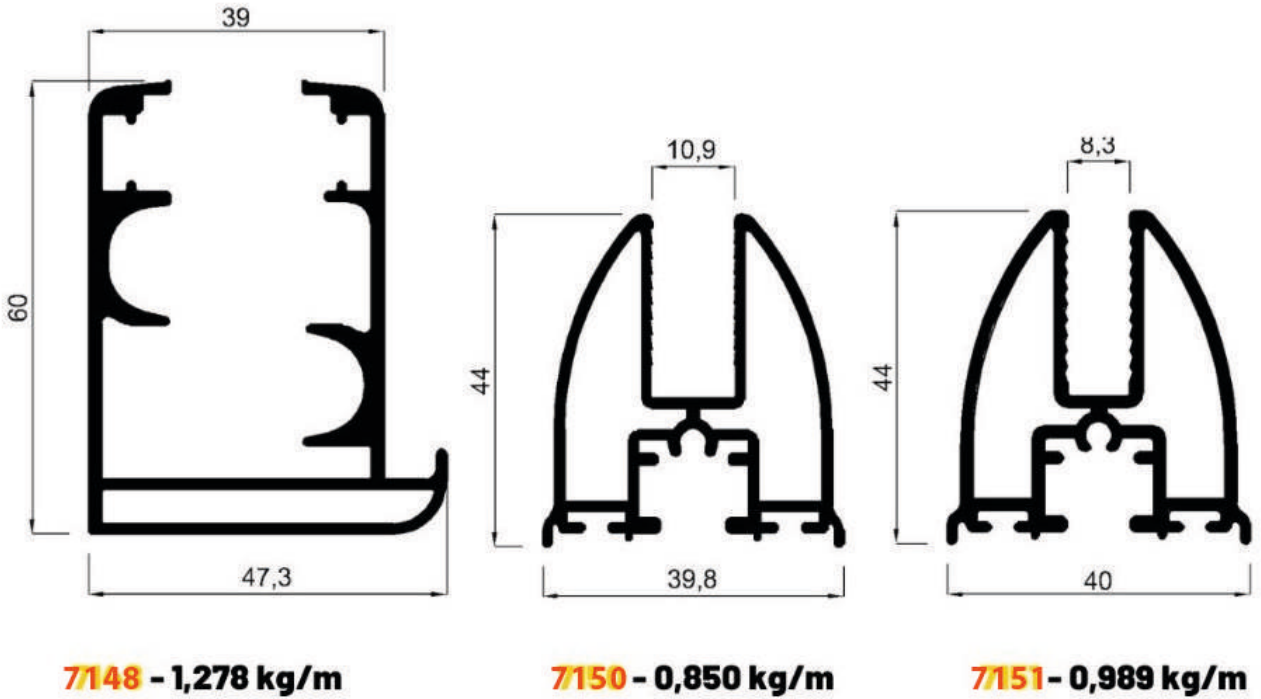
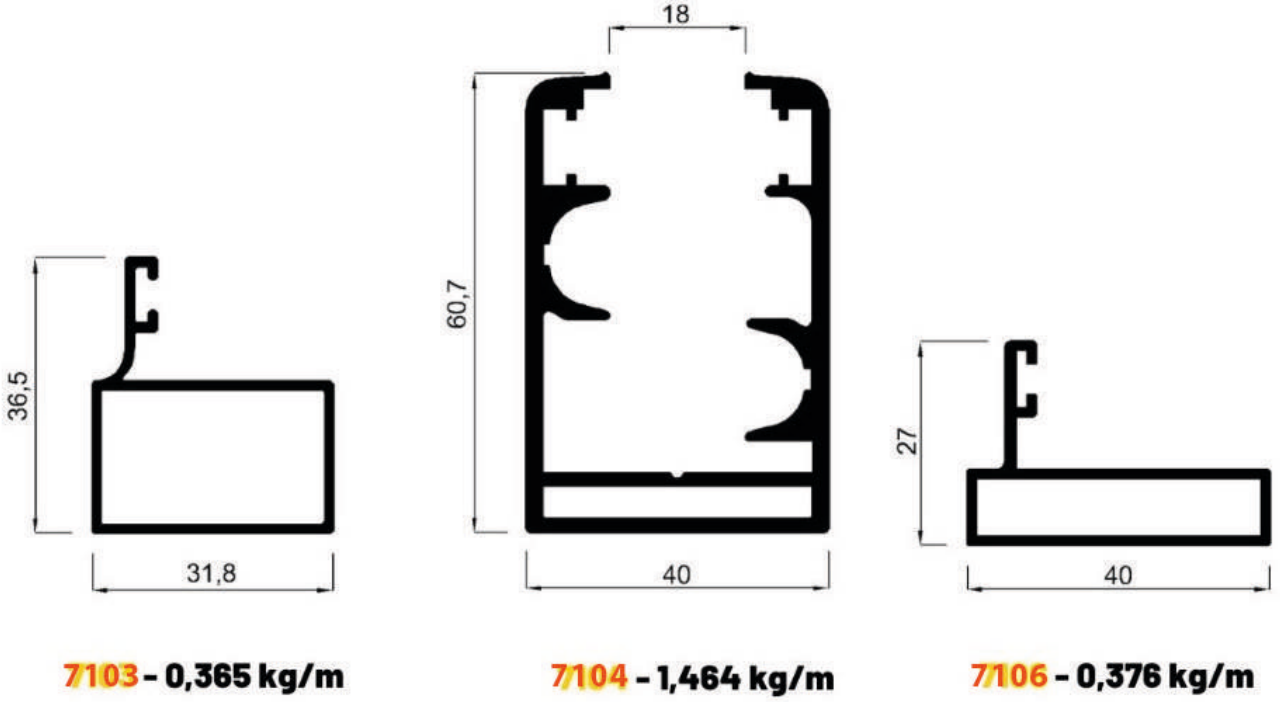

CAM BALKON SİSTEMLERİ



7206 - 0,640 kg/m



7207 - 0,378 kg/m

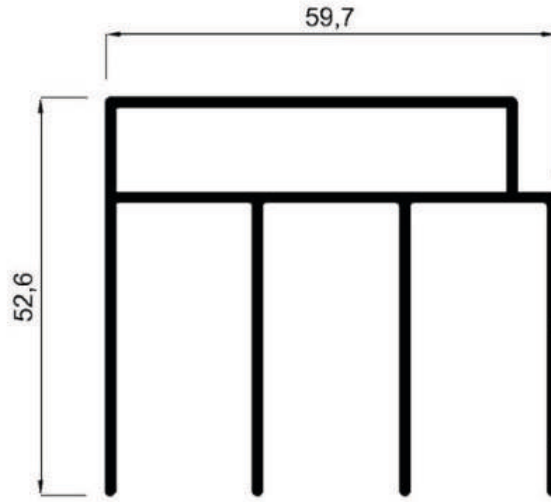

7208 - 0,949 kg/m

CAM BALKON SİSTEMLERİ

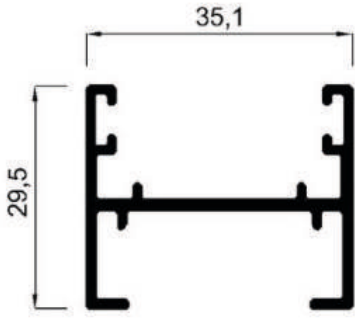

7219 - 0,417 kg/m

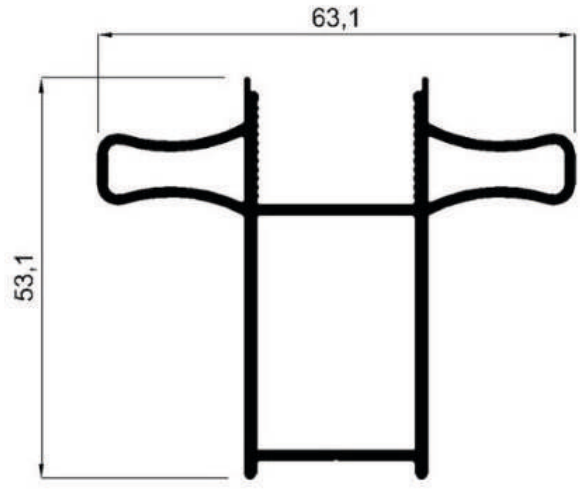

7120 - 0,848 kg/m

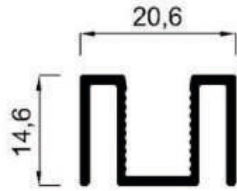

7121 - 0,235 kg/m

C60 PROFİLLERİ

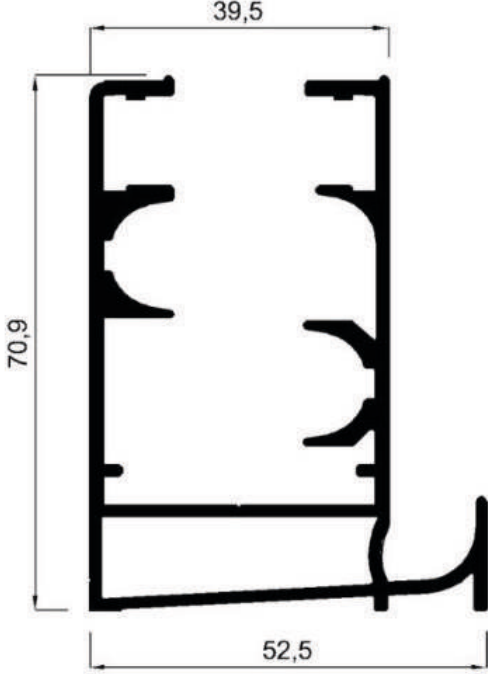

7144 - 1,420 kg/m

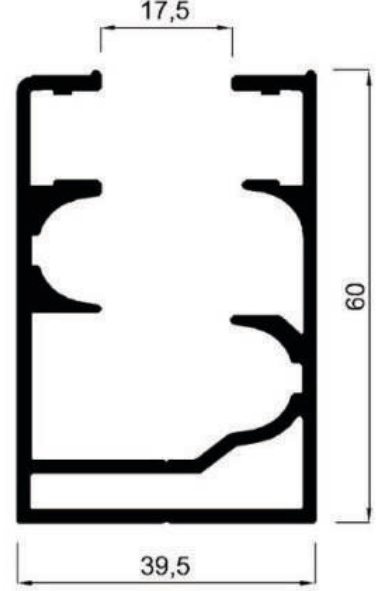

7145 - 1,198 kg/m

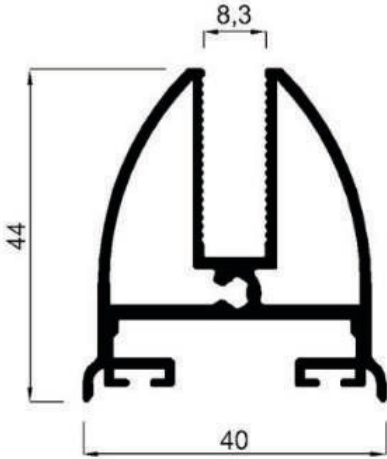

7146 - 0,837 kg/m

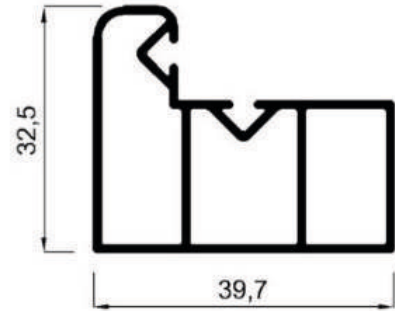

7147 - 0,469 kg/m

C60 PROFİLLERİ

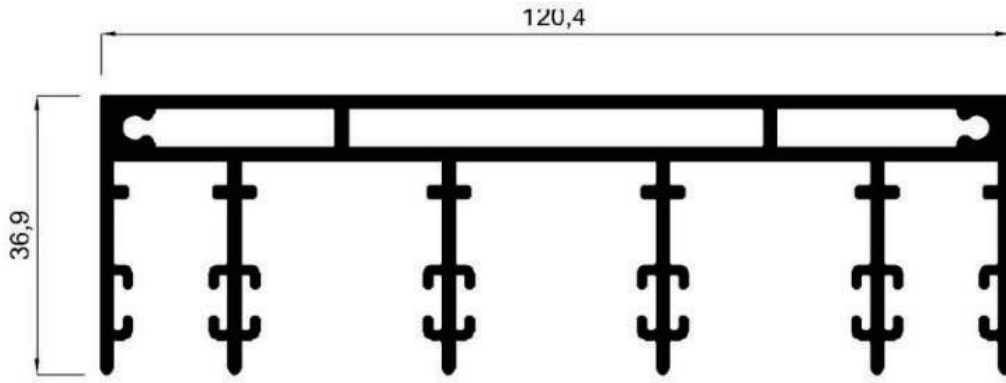

7122 - 2,292 kg/m

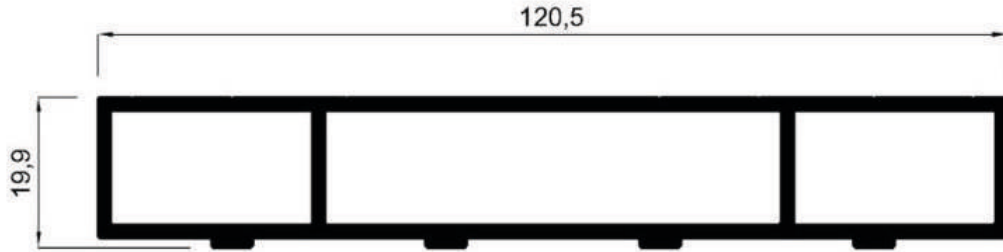

7121 - 1,526 kg/m

C60 PROFİLLERİ

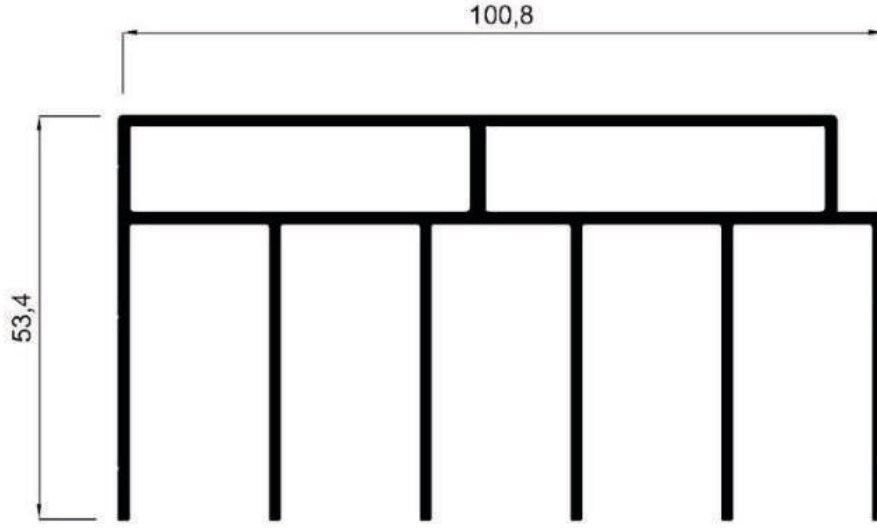

7209 - 1,635 kg/m

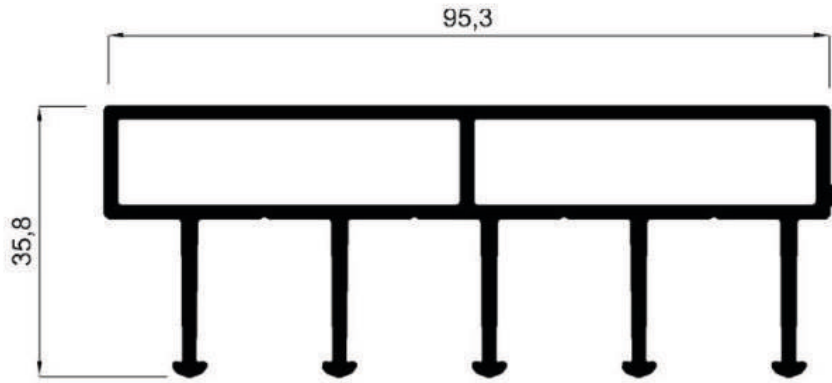

7210 - 1,567 kg/m

C60 PROFİLLERİ

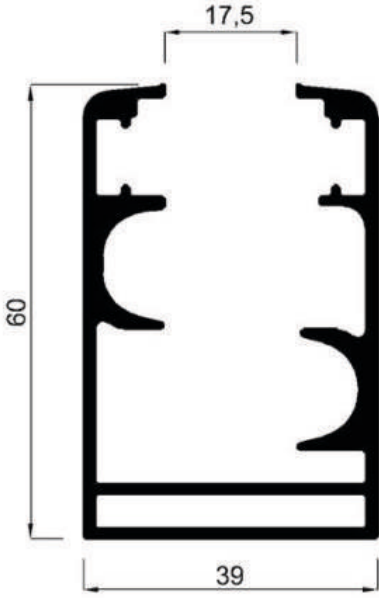

7152 - 1,218 kg/m

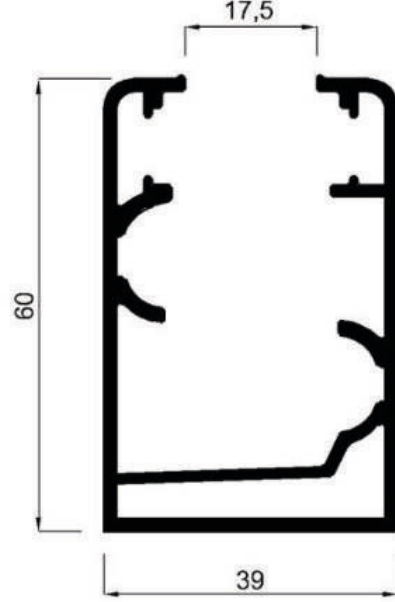

7153 - 1,153 kg/m

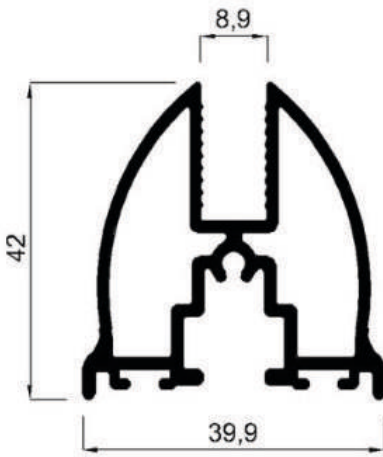

7156 - 0,878 kg/m

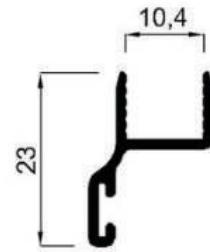

7157 - 0,147 kg/m

C60 PROFİLLERİ

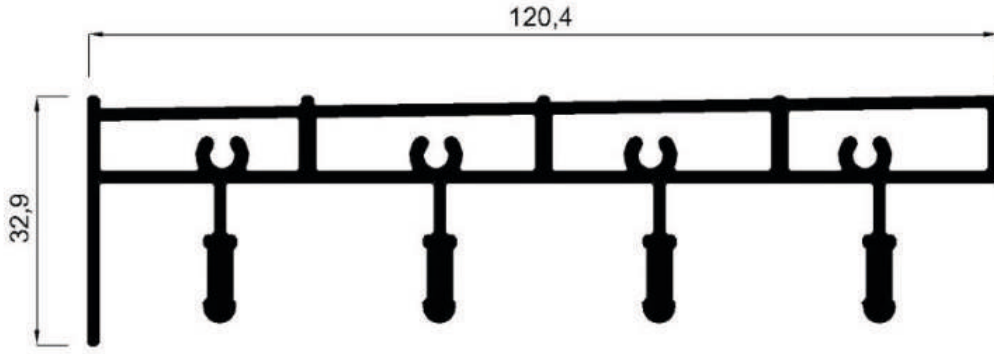

7186 - 1,911 kg/m

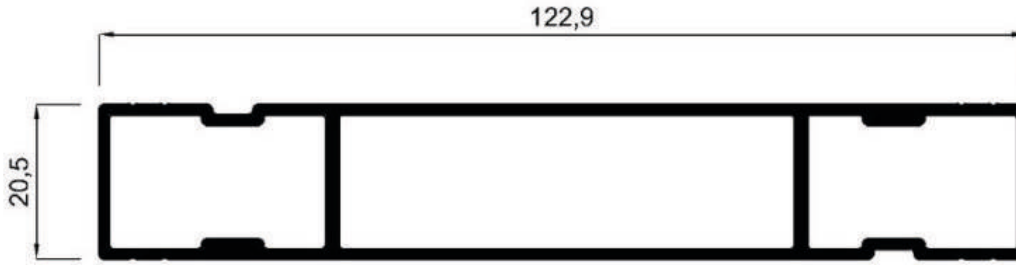

7187 - 1,267 kg/m

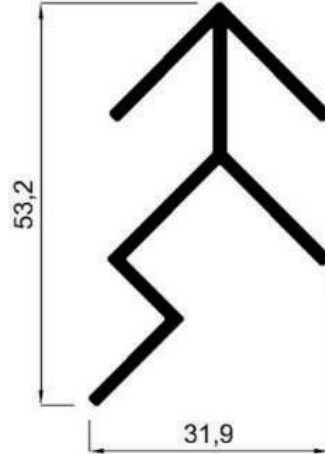

7188 - 0,501 kg/m

C60 PROFİLLERİ

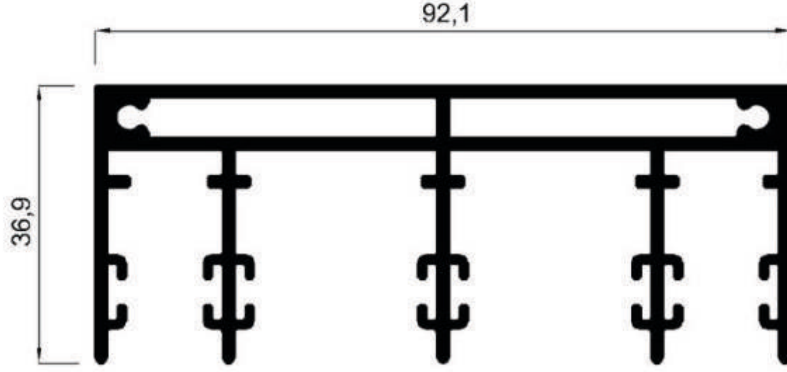

7189 - 1,847 kg/m

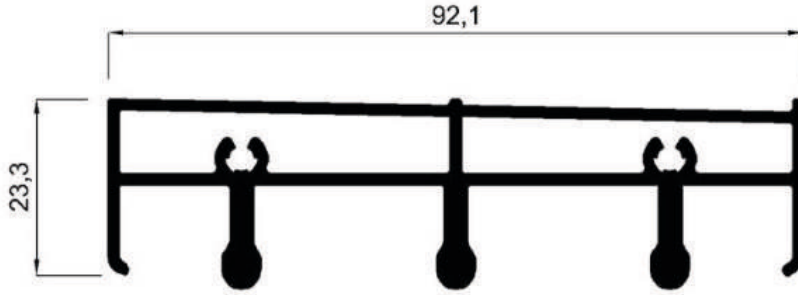

7190 - 1,372 kg/m

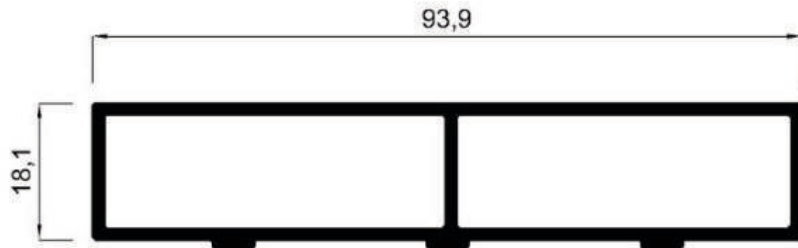

7191 - 1,003 kg/m

C60 PROFİLLERİ

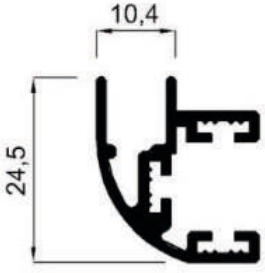

7158 - 0,334 kg/m

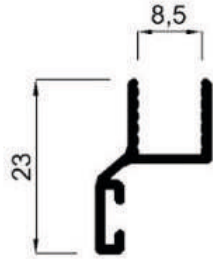

7159 - 0,152 kg/m

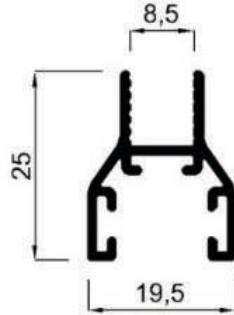

7160 - 0,248 kg/m

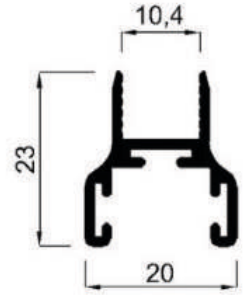

7163 - 0,241 kg/m

C60 PROFİLLERİ

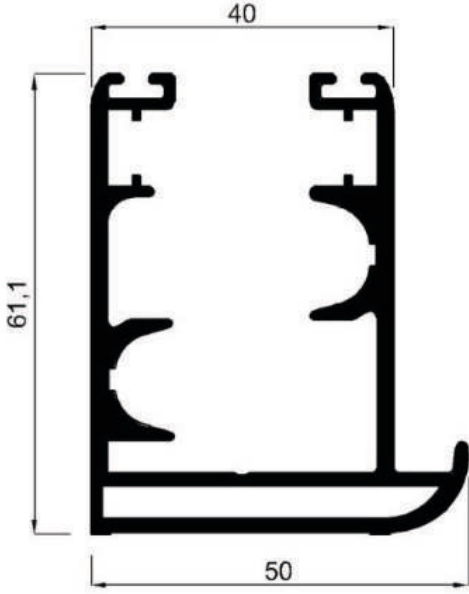

7149 - 1,539 kg/m



7154 - 0,129 kg/m



7155 - 0,097 kg/m

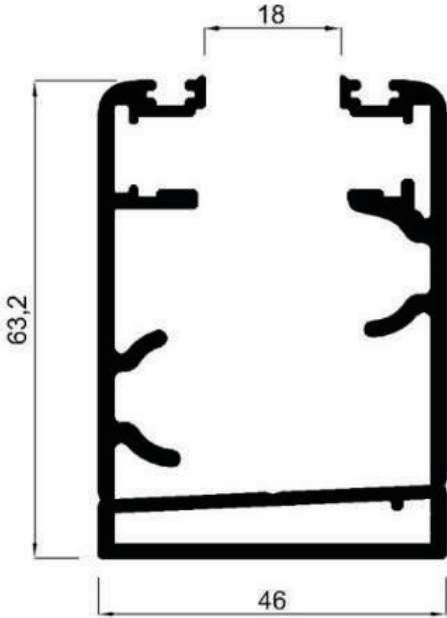

7161 - 1,580 kg/m

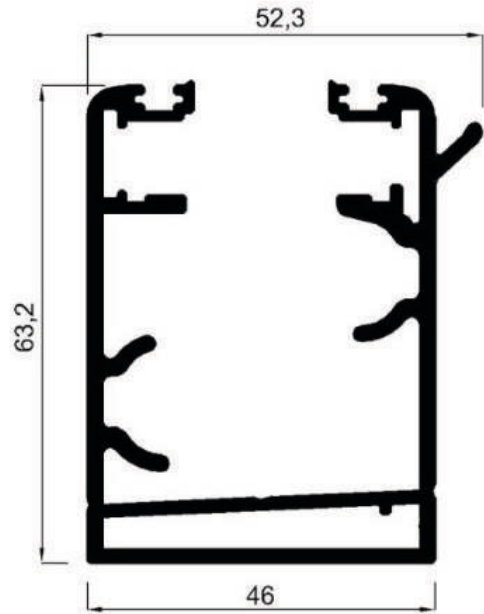

7162 - 1,626 kg/m

C60 PROFİLLERİ

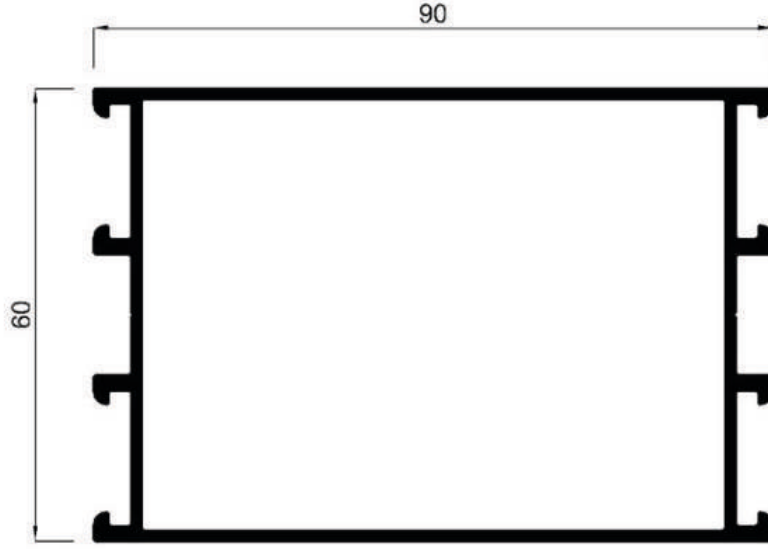

7174 - 1,328 kg/m

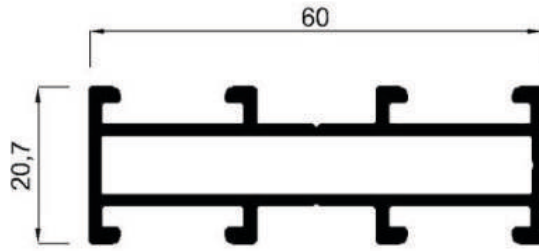

7175 - 0764 kg/m

C60 PROFİLLERİ

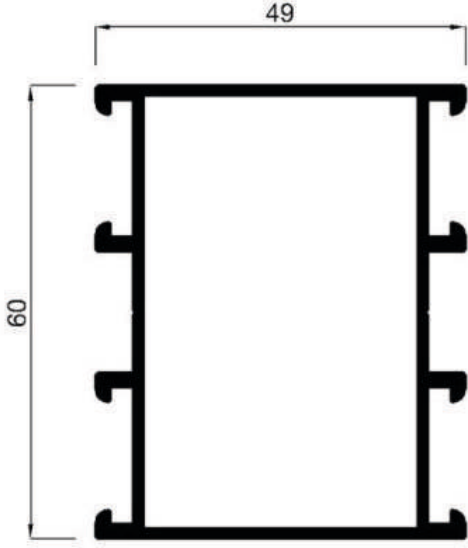

7121 - 0,992 kg/m

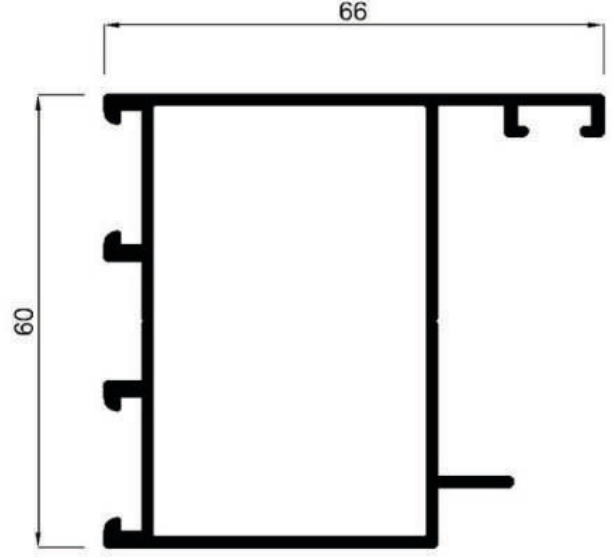

7122 - 1,008 kg/m

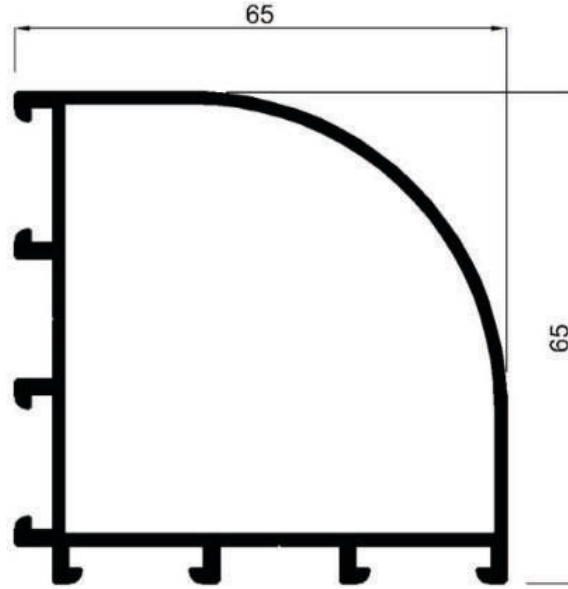

7123 - 1,122 kg/m

C60 PROFİLLERİ

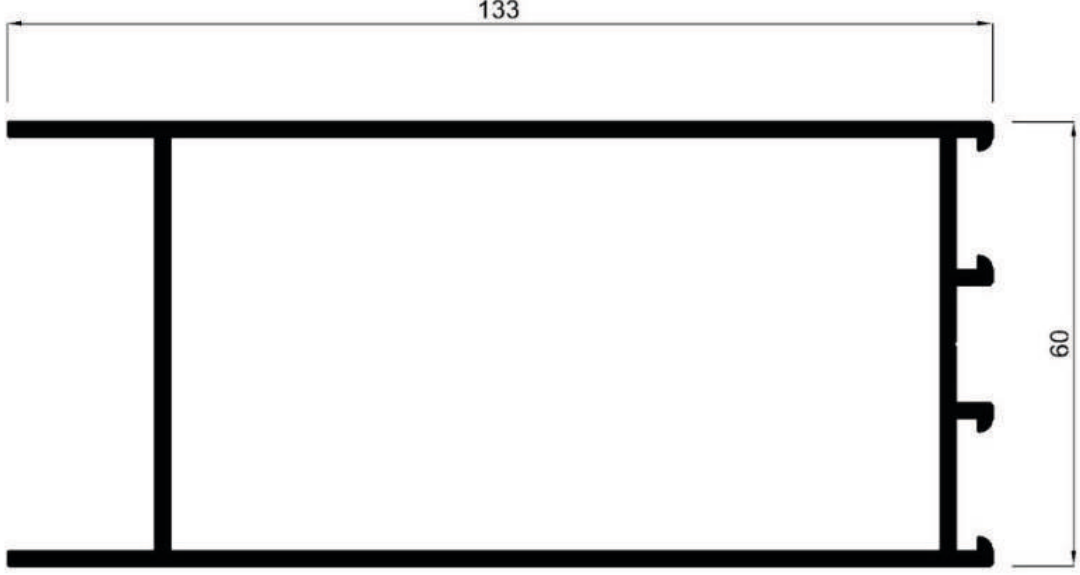

7124 - 2,138 kg/m

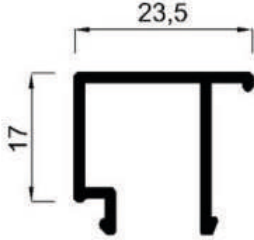

7125 - 0,234 kg/m

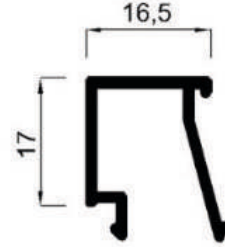

7126 - 0,225 kg/m

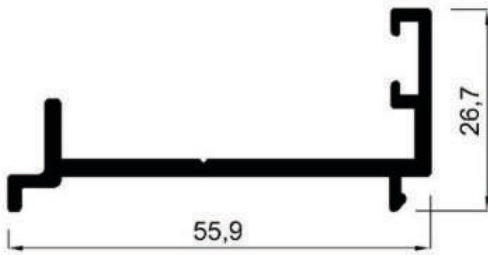

7127 - 0,551 kg/m

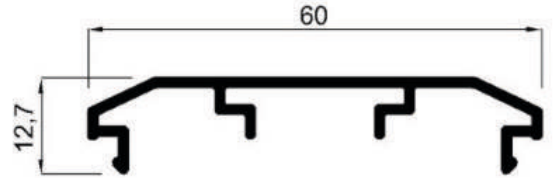

7128 - 0,348 kg/m

ALDOKS PROFİLLERİ

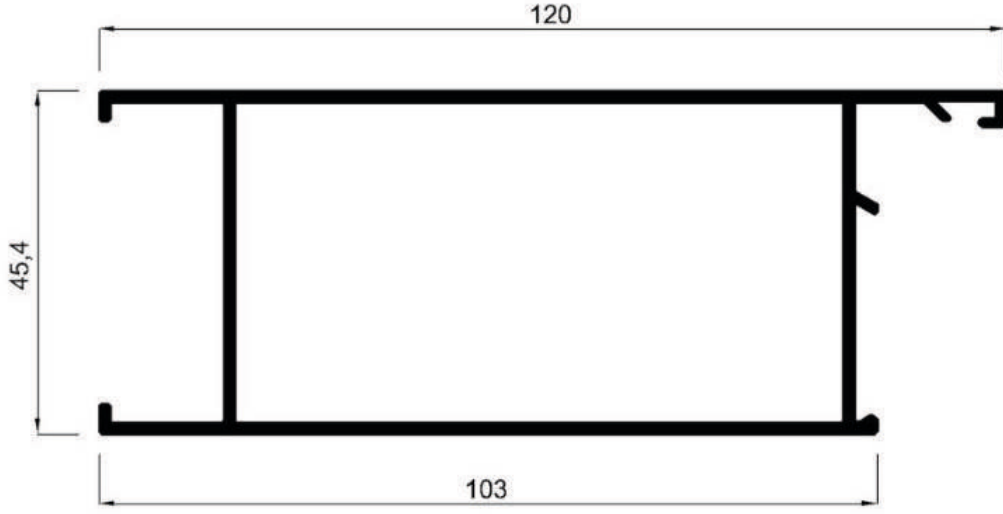

7116 - 1,313 kg/m

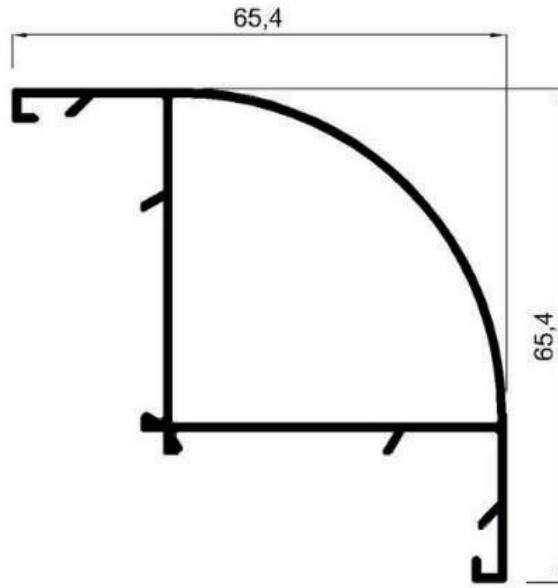

7117- 0,703 kg/m

ALDOKS PROFİLLERİ

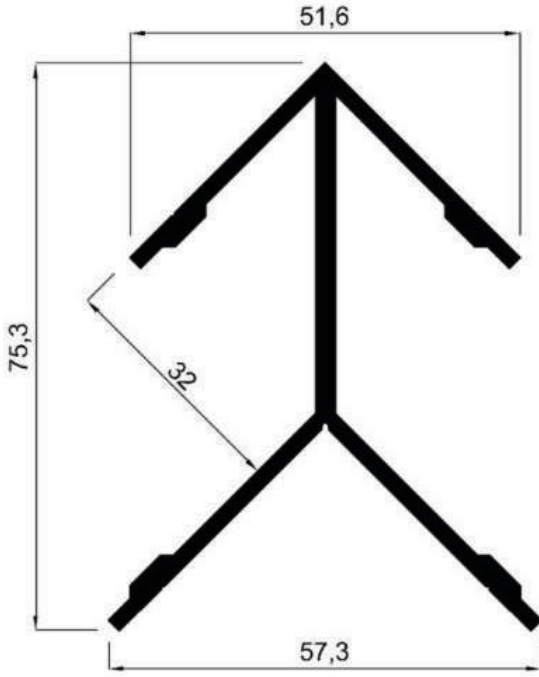

7118 - 1,186 kg/m

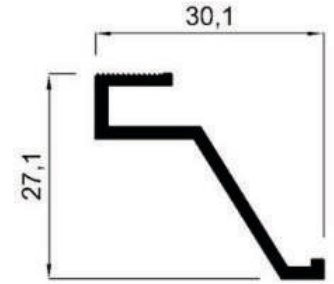

7120 - 0,227 kg/m

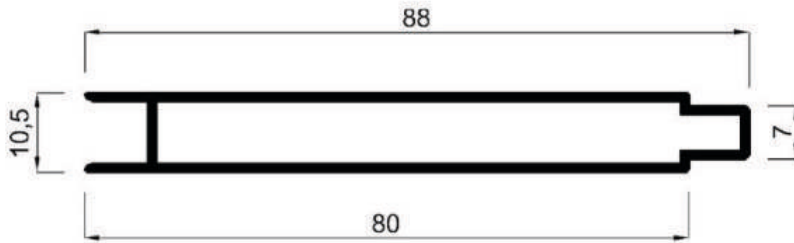

7119 - 0,572 kg/m

ALDOKS PROFİLLERİ

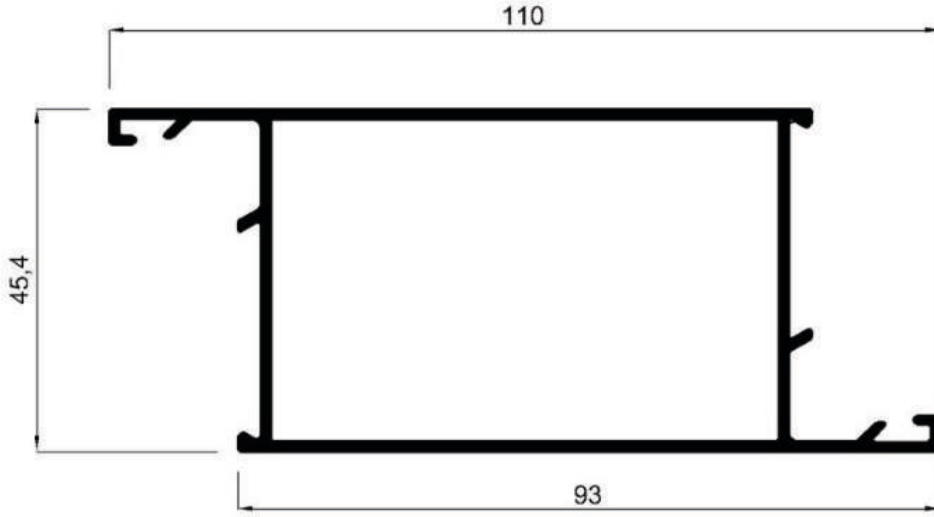

7173 - 1,124 kg/m

ALDOKS PROFİLLERİ

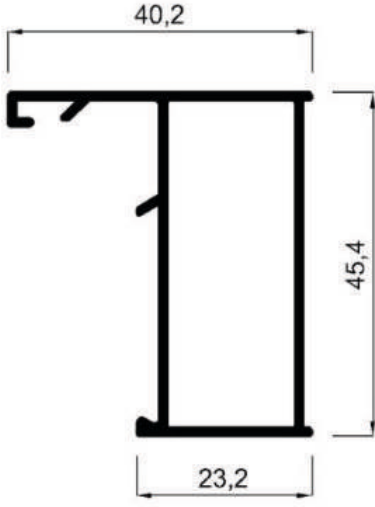

7108 - 0,493 kg/m

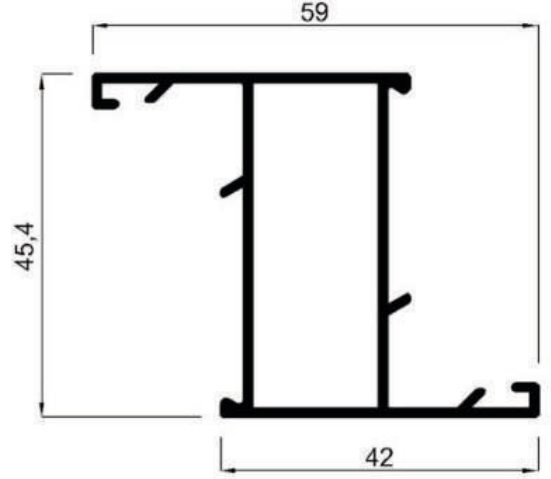

7109 - 0,598 kg/m

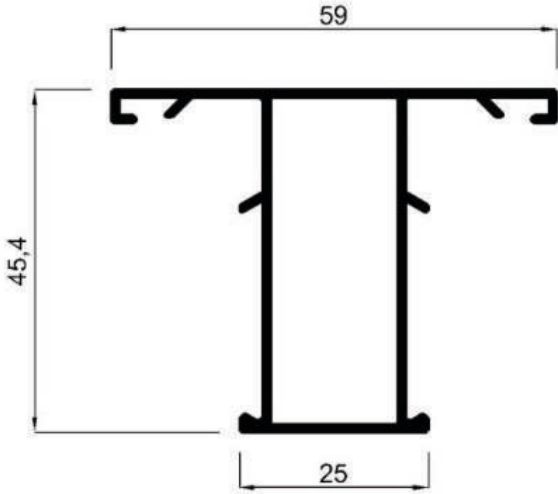

7110 - 0,598 kg/m

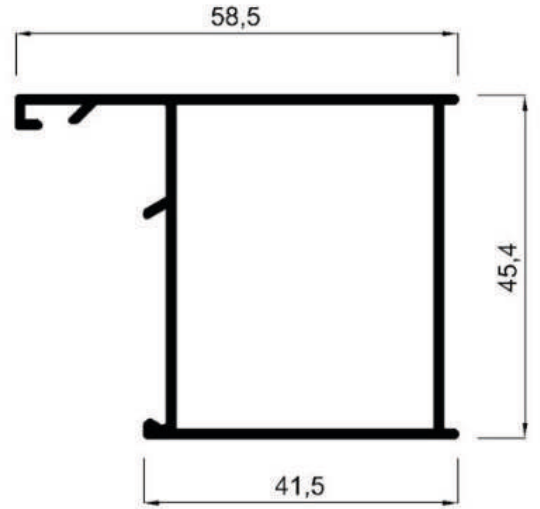

7111 - 0,601 kg/m

ALDOKS PROFİLLERİ

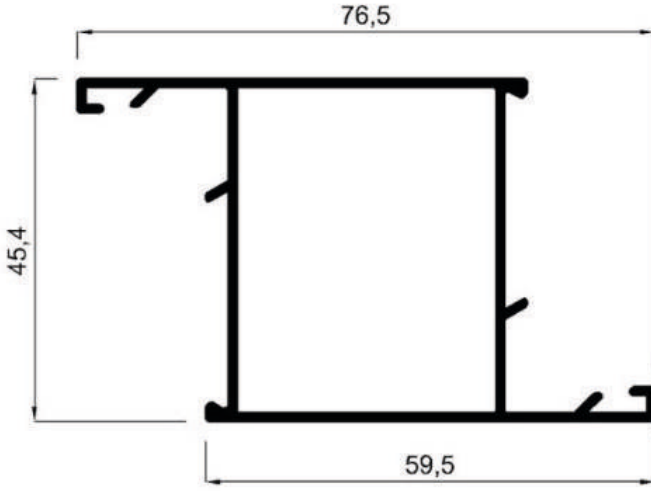

7112 - 0,703 kg/m

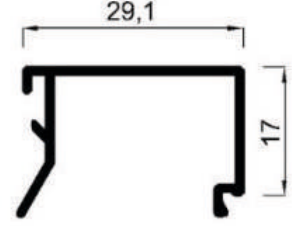

7114 - 0,209 kg/m

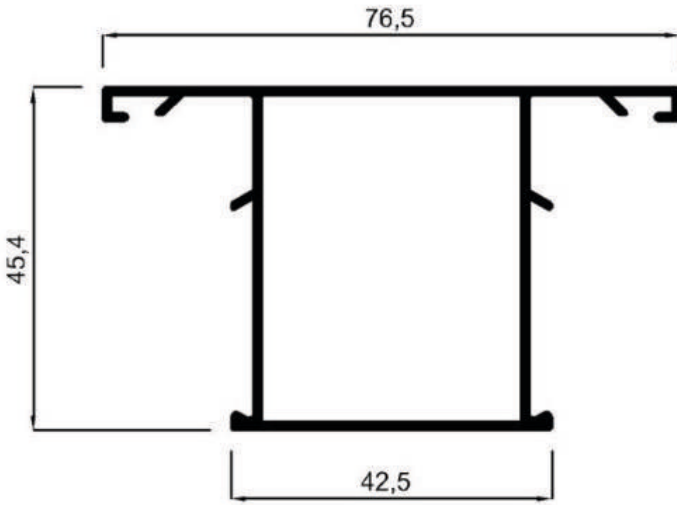

7113 - 0,703 kg/m

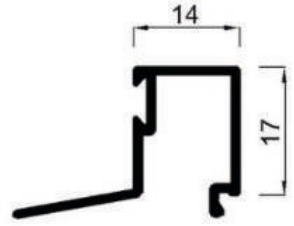

7115 - 0,204 kg/m

KÜPEŞTE PROFİLLERİ

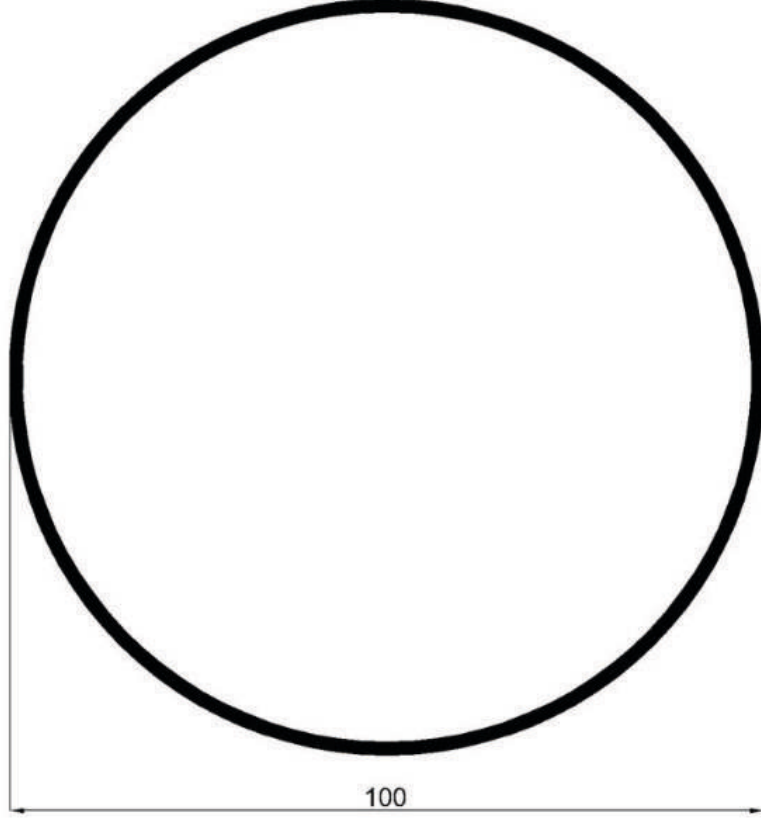

7257 - 1,381 kg/m

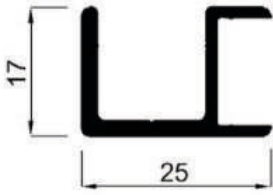

7258 - 0,276 kg/m

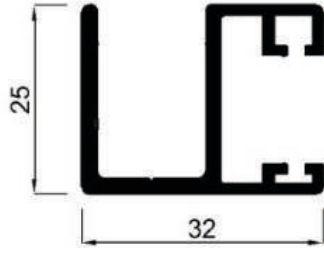

7259 - 0,510 kg/m

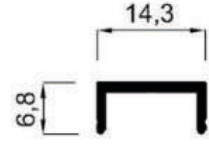

7260 - 0,076 kg/m

KÜPEŞTE PROFİLLERİ

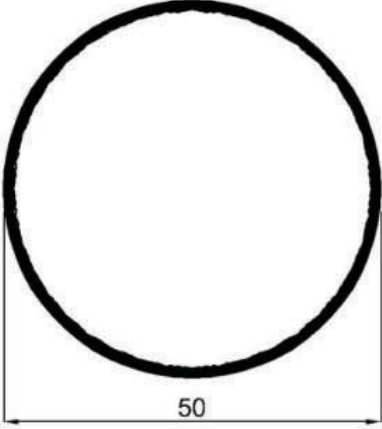

7129 - 0,555 kg/m

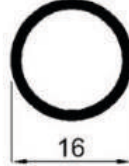

7130 - 0,147 kg/m

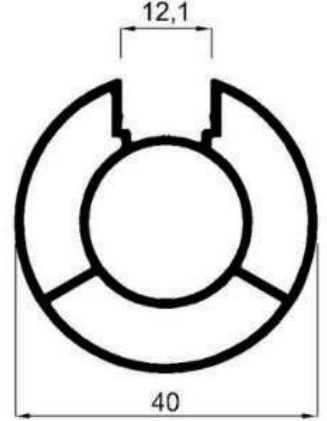

7131 - 0,604 kg/m

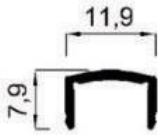

7132 - 0,066 kg/m

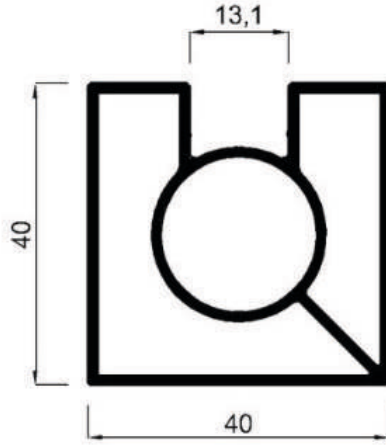

7133 - 0,872 kg/m

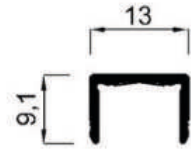

7134 - 0,079 kg/m

KÜPEŞTE PROFİLLERİ



7135 - 0,201 kg/m

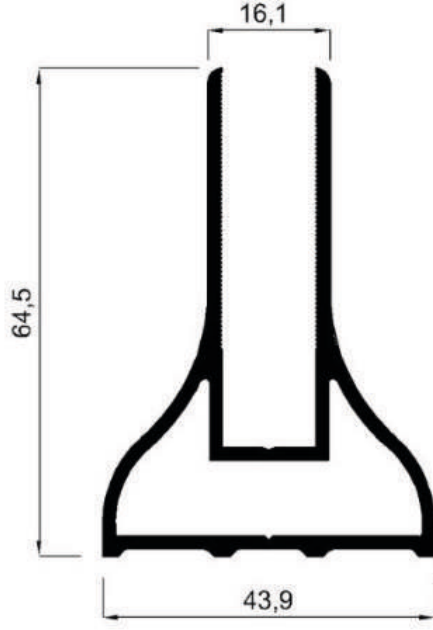

7136 - 0,977 kg/m

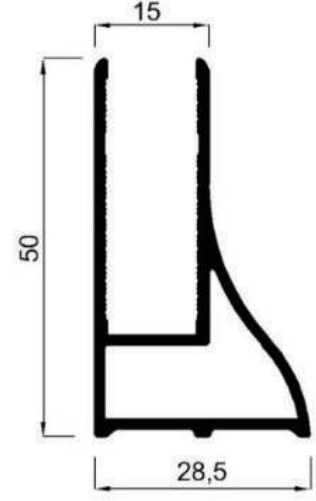

7137 - 0,555 kg/m

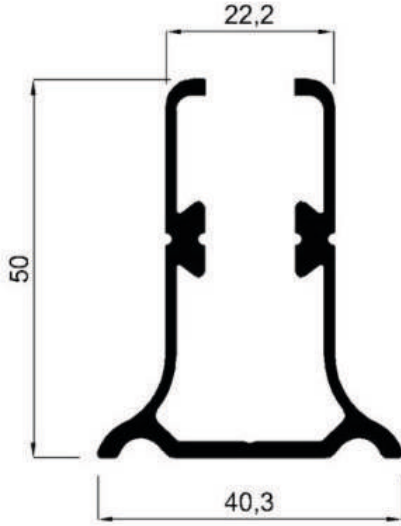

7138 - 0,748 kg/m

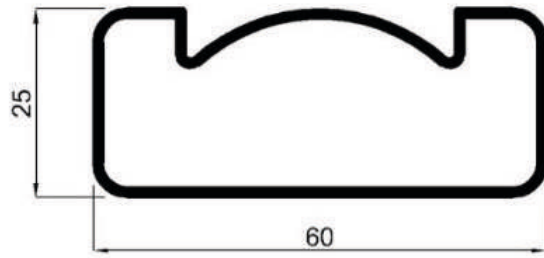

7139 - 0,613 kg/m

KÜPEŞTE PROFİLLERİ

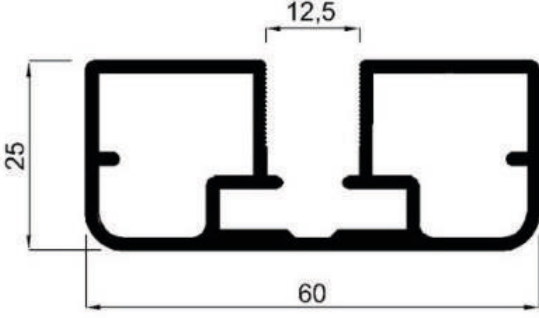

7140 - 0,924 kg/m

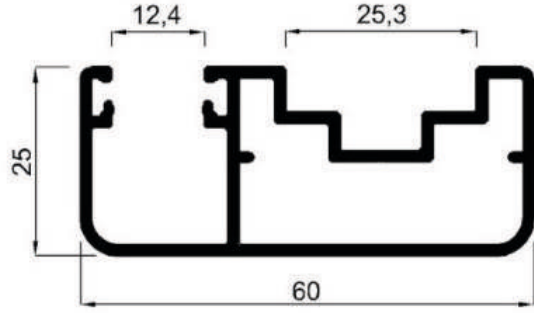

7141 - 0,781 kg/m

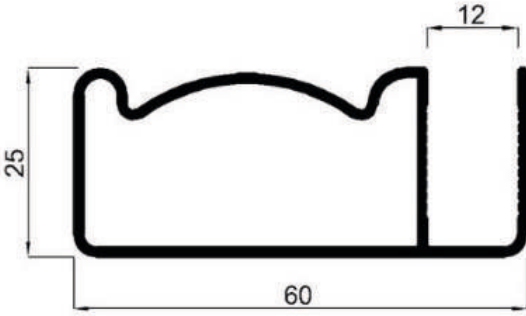

7142 - 0,603 kg/m

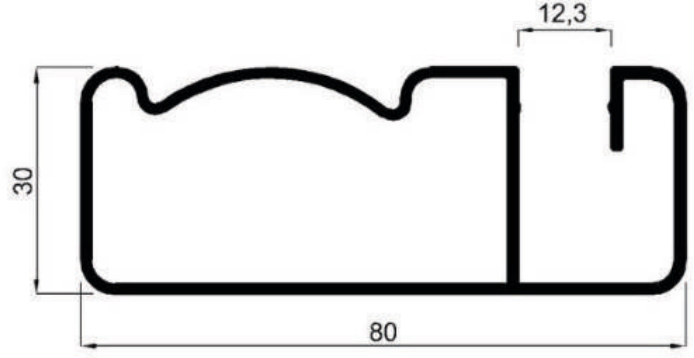

7143 - 0,876 kg/m

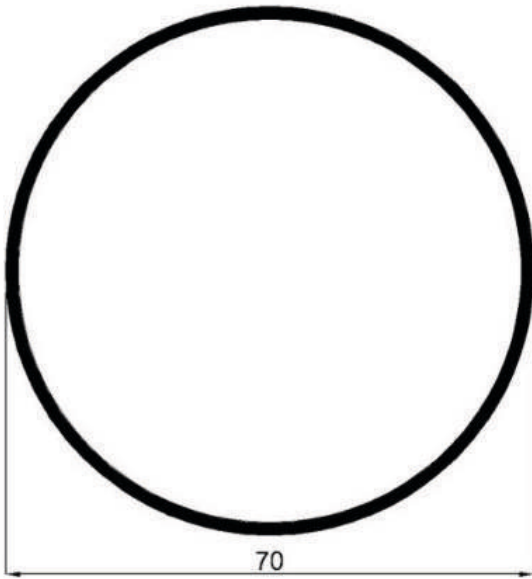

7256 - 0,989 kg/m

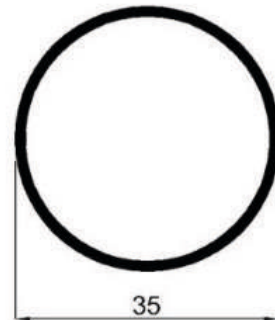

7261 - 0,344 kg/m

MENFEZ PROFİLLERİ

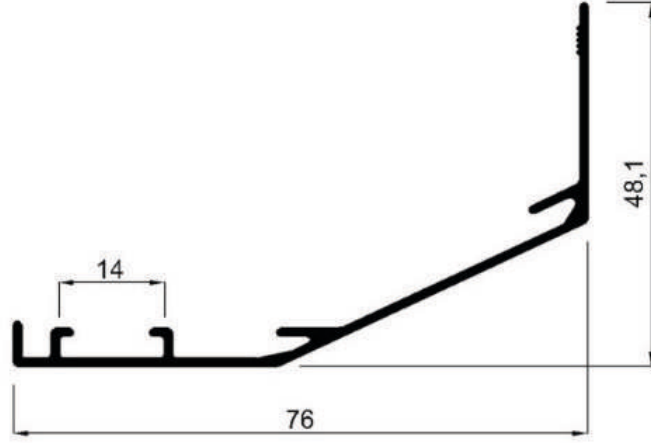

1134 - 0,400 kg/m

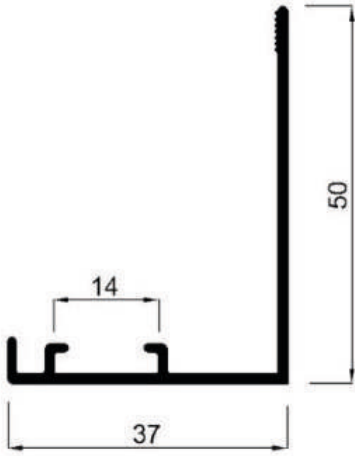

1136 - 0,328 kg/m

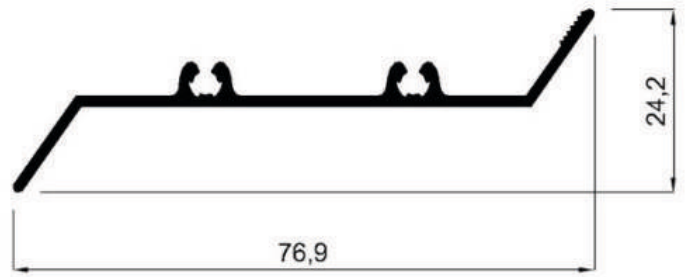

1137 - 0,374 kg/m

MENFEZ PROFİLLERİ

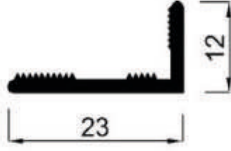

1139 - 0,374 kg/m

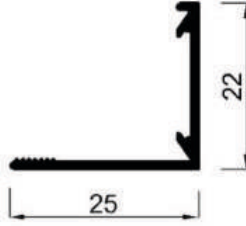

1140 - 0,150 kg/m

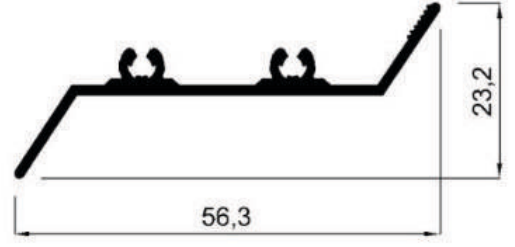

1141 - 0,312 kg/m

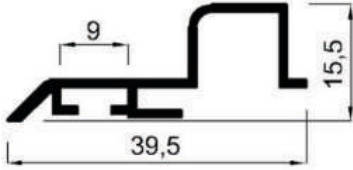

1142 - 0,220 kg/m

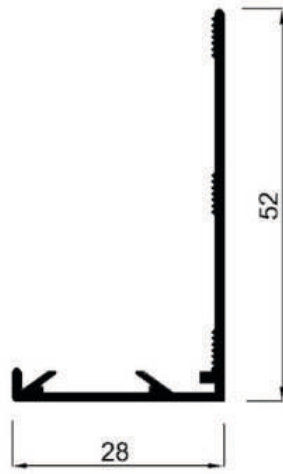

1143 - 0,309 kg/m

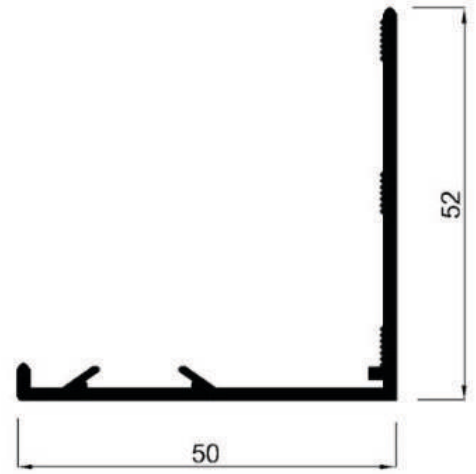

1144 - 0,464 kg/m

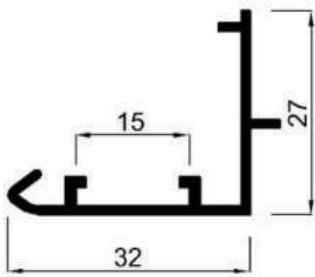

1200 - 0,243 kg/m



1590 - 0,070 kg/m

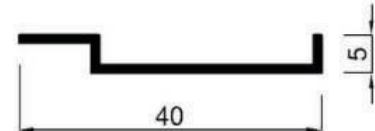

1591 - 0,130 kg/m

MENFEZ PROFİLLERİ

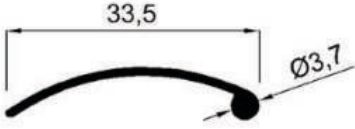

1592 - 0,108 kg/m

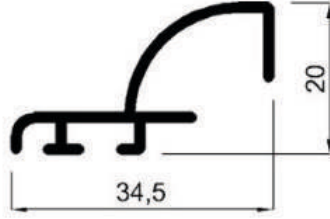

1950 - 0,255 kg/m

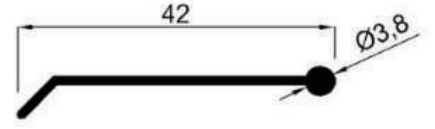

2016 - 0,127 kg/m

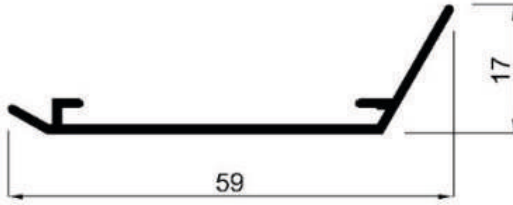

2018 - 0,220 kg/m

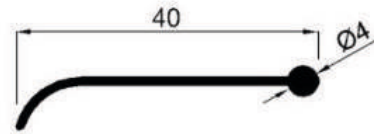

2453 - 0,138 kg/m

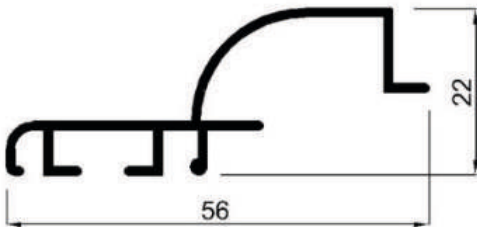

2454 - 0,314 kg/m

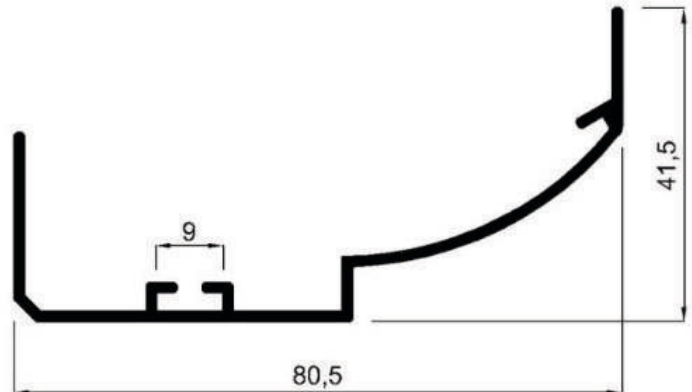

2650 - 0,526 kg/m

MENFEZ PROFİLLERİ

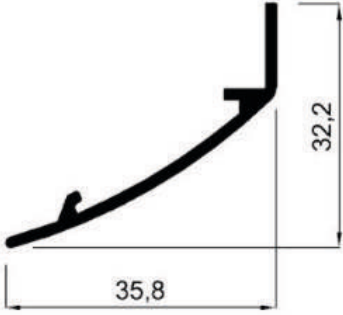

2651 - 0,222 kg/m

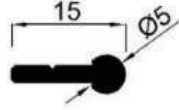

2652 - 0,106 kg/m

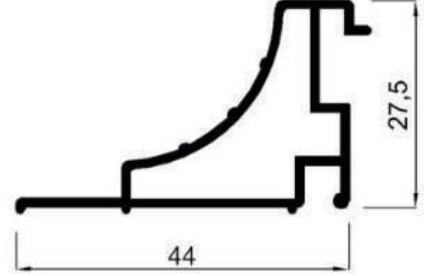

4000 - 0,360 kg/m

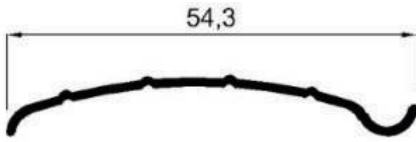

4001 - 0,163 kg/m

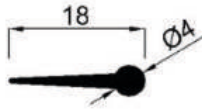

5075 - 0,079 kg/m

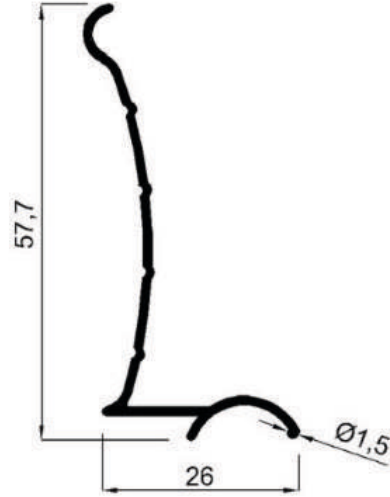

4002 - 0,247 kg/m

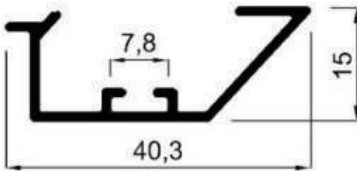

7105 - 0,219 kg/m

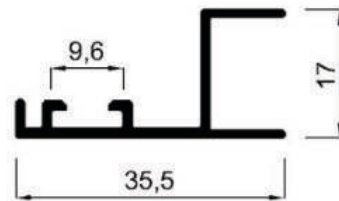

8170 - 0,228 kg/m

MENFEZ PROFİLLERİ

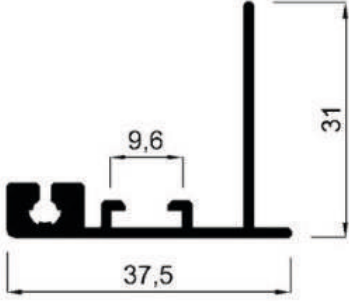

8171 - 0,353 kg/m

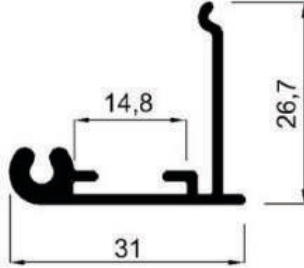

8230 - 0,290 kg/m

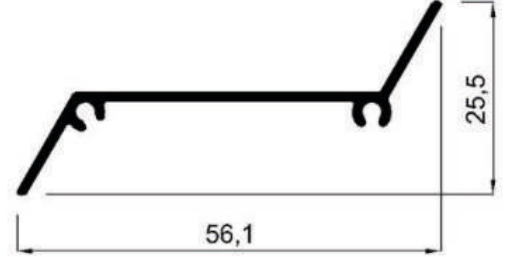

8345 - 0,247 kg/m

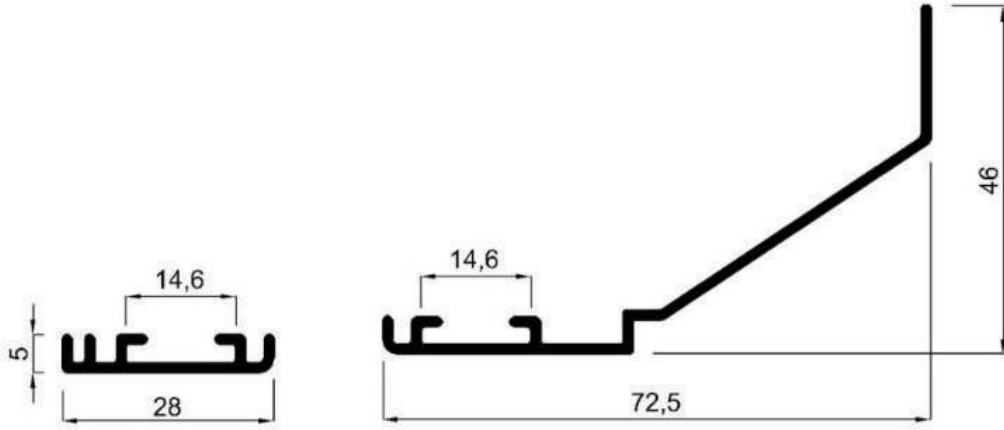

8395 - 0,168 kg/m

8396 - 0,382 kg/m

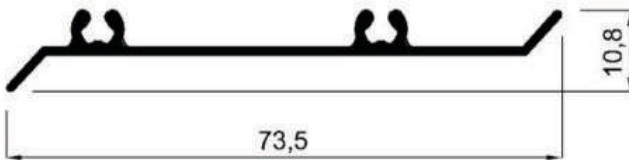

8405 - 0,303 kg/m

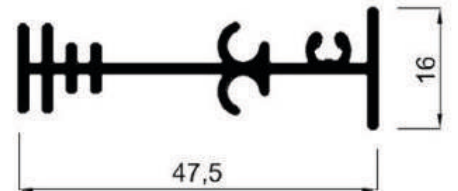

8410 - 0,398 kg/m

MENFEZ PROFİLLERİ

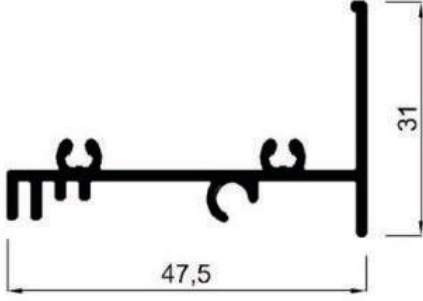

8411 - 0,398 kg/m

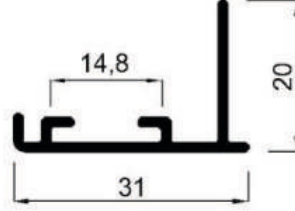

8472 - 0,197 kg/m

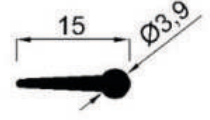

8489 - 0,077 kg/m

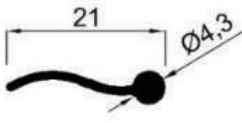

8490 - 0,086 kg/m

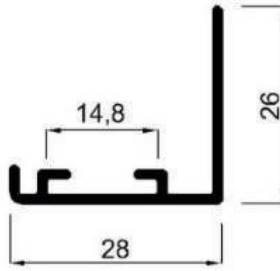

8491 - 0,206 kg/m

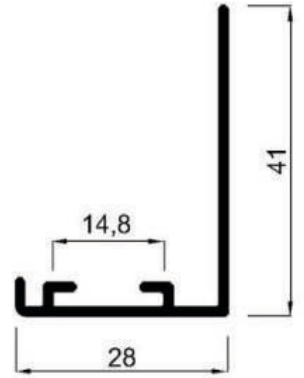

8492 - 0,251 kg/m

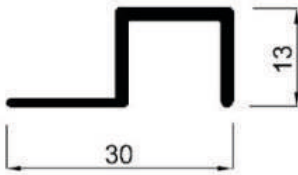

8506 - 0,195 kg/m

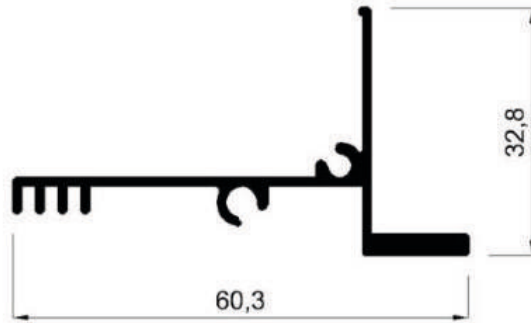

8507 - 0,419 kg/m

MENFEZ PROFİLLERİ

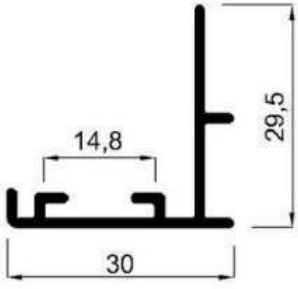

8536 - 0,234 kg/m

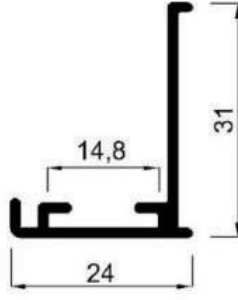

8537 - 0,216 kg/m

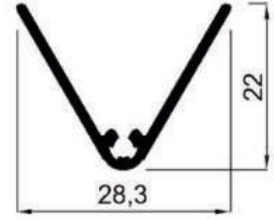

8538 - 0,171 kg/m

MENFEZ PROFİLLERİ

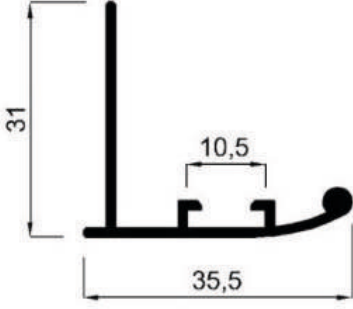

1126 - 0,252 kg/m

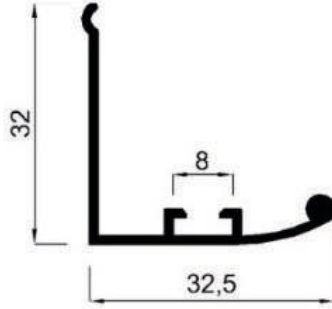

1127 - 0,225 kg/m

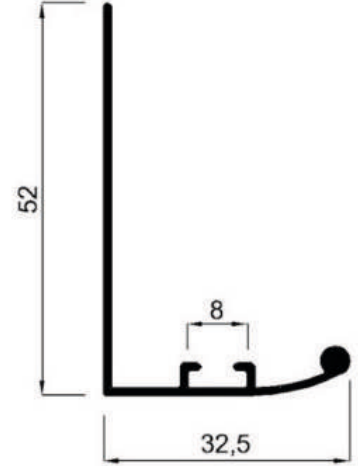

1128 - 0,241 kg/m

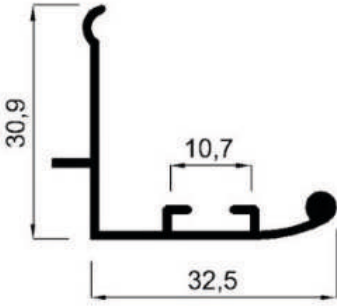

1129 - 0,240 kg/m

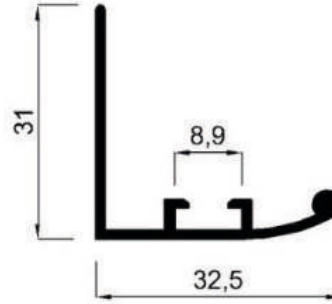

1130 - 0,250 kg/m

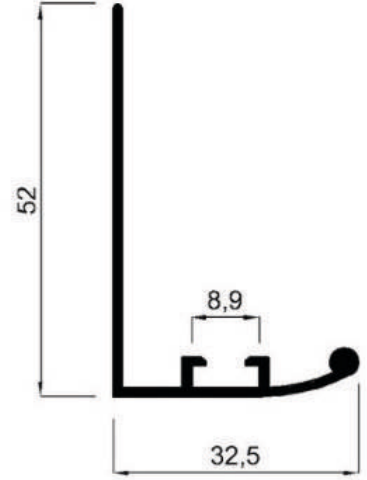

1131 - 0,312 kg/m

KEPENK PROFİLLERİ

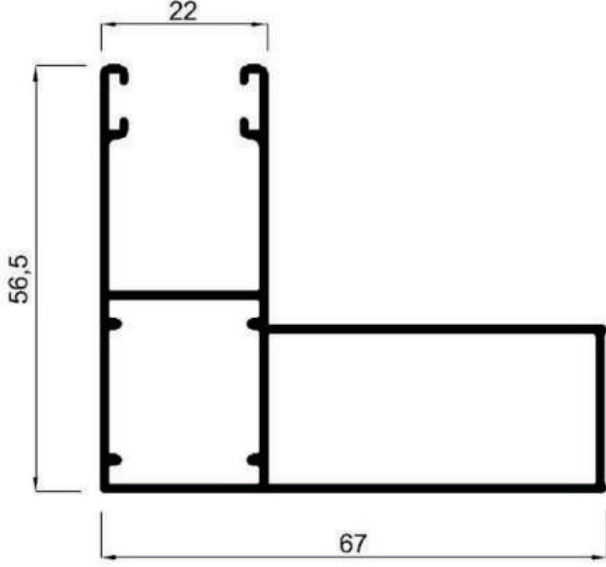

8426 - 0,702 kg/m

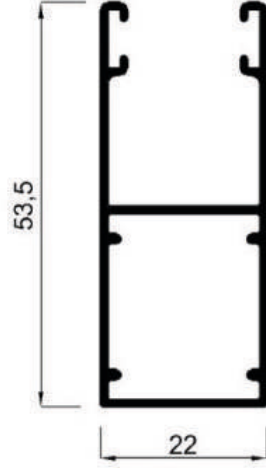

8427 - 0,420 kg/m



8428 - 0,277 kg/m

KEPENK PROFİLLERİ

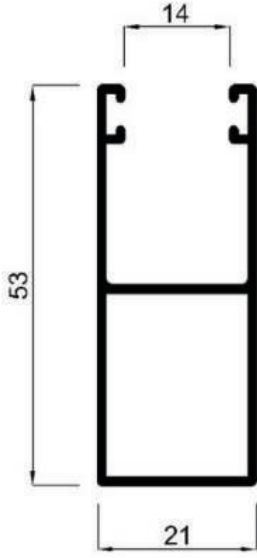

810 - 0,431 kg/m



5110 - 0,255 kg/m

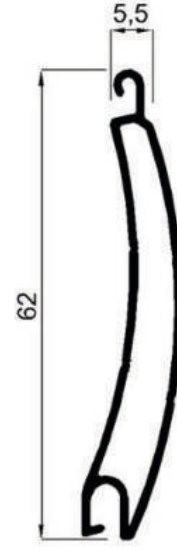

7227 - 0,341 kg/m

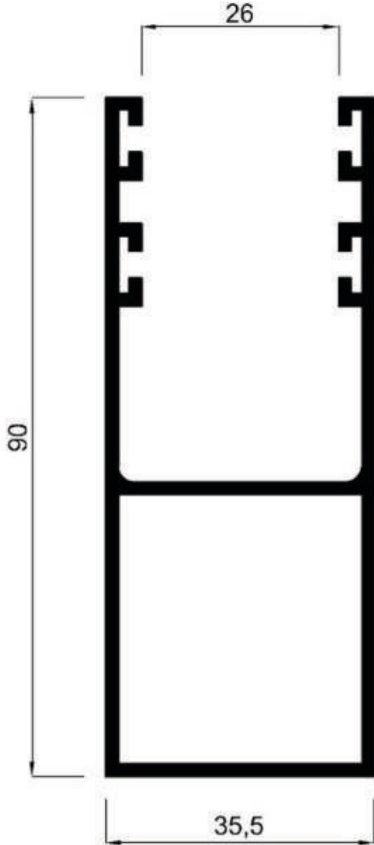

7225 - 1,253 kg/m

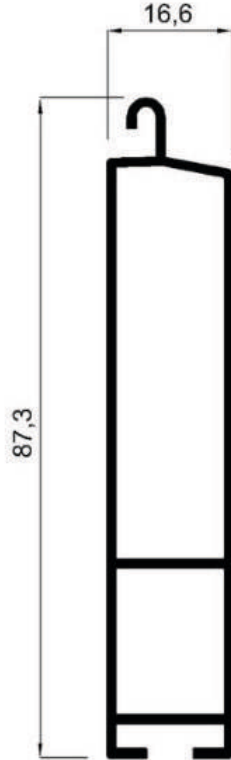

7224 - 0,632 kg/m

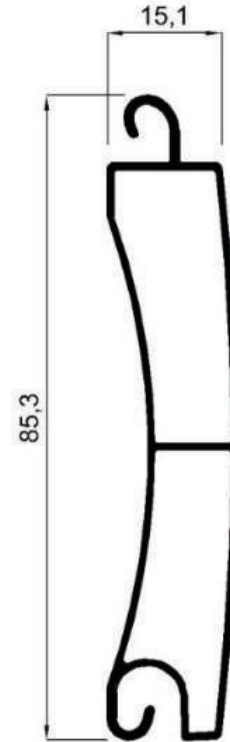

7226 - 0,484 kg/m

STANDART PROFİLLER

L Profiller

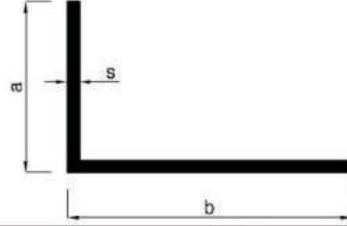

NO	a(mm)	b(mm)	s(mm)	kg /m
520	20	30	1,5	0,198
512	20	40	1,5	0,238
513	20	50	1	0,187
5107	20	60	1,2	0,260
5029	25	25	1,2	0,160
517	25	25	1,5	0,198
5066	30	30	1	0,160
5165	30	30	1,1	0,175
8073	30	30	1,5	0,240
8628	30	30	3	0,463
8629	30	30	4	0,607

STANDART PROFİLLER

L Profiller

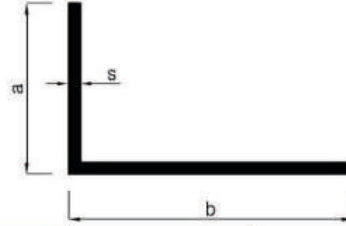

NO	a(mm)	b(mm)	s(mm)	kg /m
8189	35	35	1,5	0,279
518	40	40	1,5	0,320
550	40	40	4	0,823
8793	45	46	3	0,703

STANDART PROFİLLER

Kutu Profiller

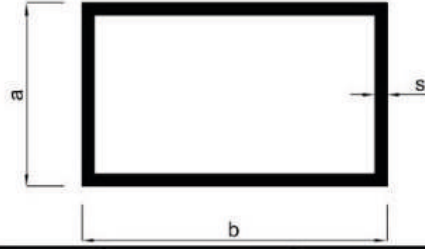

NO	a(mm)	b(mm)	s(mm)	kg /m
3373	7,5	11,8	1,5	0,133
8097	8	8	1	0,077
949	10	20	1	0,152
3366	12,6	12,6	1,05	0,127
7135	14	14	1,3	0,201
5115	15	15	1,5	0,211
8617	15	30	0,9	0,199
8080	16	16	1,5	0,236
8217	17	20	1,5	0,276
5405	17	28	1,2	0,258
8403	20	20	1	0,198

STANDART PROFİLLER

Kutu Profiller

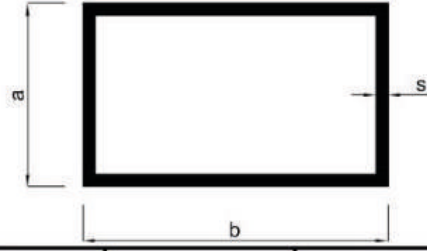

NO	a(mm)	b(mm)	s(mm)	kg /m
8114	20	20	1,5	0,302
8596	20	30	1,2	0,309
703	20	40	1	0,315
8218	23,8	23,8	1,5	0,352
8575	25	25	0,85	0,222
8188	25	25	1,5	0,382
5010	28	68	0,9	0,460
8156	30	70	0,7	0,375
5031	38	48	0,9	0,412
702	38	48	1	0,460
700	40	40	1	0,425

STANDART PROFİLLER

Kutu Profiller

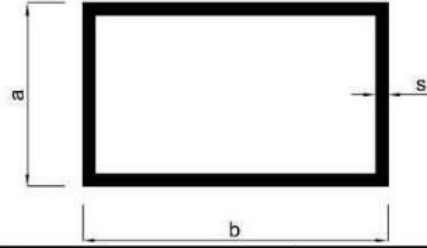

NO	a(mm)	b(mm)	s(mm)	kg /m
709	40	40	2	0,824
8742	40	60	1,3	0,686
8741	40	80	1,3	0,826

STANDART PROFİLLER

Lama Profiller

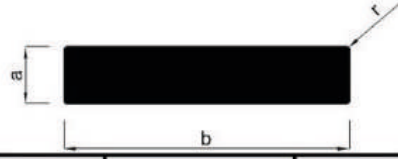

NO	a(mm)	b(mm)	r(mm)	kg /m
2975	2	10	0,15	0,054
8128	2	12	1	0,062
981	2	15	0,3	0,081
982	2	20	0,3	0,108
977	2	25	0,2	0,136
8187	2	35	0,25	0,190
8075	2	40	0	0,217
983	2	50	0,3	0,271
8493	2,9	12	0,3	0,094
2977	3	5	0	0,041
8005	3	20	1,5	0,157

STANDART PROFİLLER

Lama Profiller

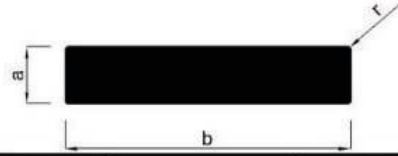

NO	a(mm)	b(mm)	r(mm)	kg /m
8207	3	25	0,5	0,203
8284	3	25	1,5	0,198
8675	3,2	92	0,2	0,797
5016	3,5	30	1,75	0,276
8542	5	20	0	0,271
8666	5	100	0,5	1,355
8184	6	20	2	0,317
8543	6	25	0	0,406
3378	7	17	0,5	0,322
3375	7	30	0,5	0,570
3379	8	20	0,5	0,434

STANDART PROFİLLER

Lama Profiller

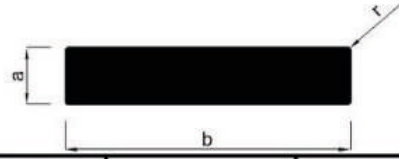

NO	a(mm)	b(mm)	r(mm)	kg /m
8730	8	40	0	0,867
8130	10	20	0,5	0,542
8748	12	70	0	2,284
5020	23,9	50,9	0	3,300

STANDART PROFİLLER

T Profiller

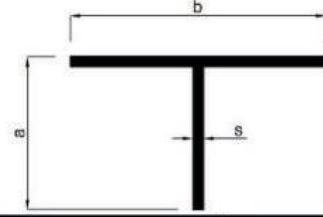

NO	a(mm)	b(mm)	s(mm)	kg /m
8081	20	20	1,5	0,157
611	30	30	1,2	0,190
8029	50	50	2,3	0,610
8028	70	50	2,3	0,856

STANDART PROFİLLER

U Profiller



NO	a(mm)	b(mm)	s(mm)	kg / m
5415	5,8	25,6	0,8	0,076
8082	8	13,5	1,5	0,109
3368	8,9	11	1,9	0,130
2011	10	9	1	0,074
951	10	10	1	0,076
8076	10	13	1,5	0,122
8110	10	20	1,5	0,150
8111	10	23	1,5	0,163
8009	12	12	1	0,092
952	15	10	1	0,103
8112	15	15	1,5	0,171

STANDART PROFİLLER

U Profiller



NO	a(mm)	b(mm)	s(mm)	kg /m
8160	15	19	1,5	0,187
8077	15	20	1,5	0,193
8436	15	45	2	0,385
2015	16	16	1	0,125
2012	16	17,5	0,9	0,117
8079	20	15	1,5	0,212
8113	20	20	1,5	0,232
8008	20	21,6	1,2	0,192
7262	20	22,6	1,4	0,227
7263	20,7	20,15	1,4	0,222
8522	21,9	17,8	1,1	0,176

STANDART PROFİLLER

U Profiller

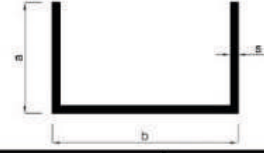

NO	a(mm)	b(mm)	s(mm)	kg /m
8477	25	20,5	1,5	0,287
6007	25	24,2	1	0,195
6009	27,5	12,5	1	0,180
8030	41	75	3	1,228

STANDART PROFİLLER

Yuvarlak Çubuklar

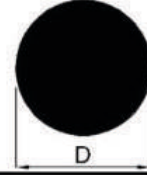

NO	D(mm)	kg /m
8115	4	0,034
2960	6	0,080
614	8	0,136
8126	9,8	0,204
3203	12	0,306
5308	14	0,417
8593	17	0,615
8065	19,75	0,829

STOR PERDE PROFİLLER

Yuvarlak Borular

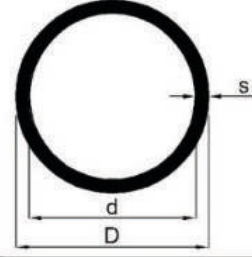

NO	D(mm)	d(mm)	s(mm)	kg /m
3105	12	10	1	0,095
5099	12	10,4	0,8	0,076
8540	13,4	10,4	1,5	0,151
8731	14	11,6	1,2	0,130
7130	16	13,6	1,2	0,151
8116	16	14	1	0,128
3404	17	15,4	0,8	0,112
5130	18,6	15,6	1,5	0,218
5111	19	13	3	0,409
5076	20	17	1,5	0,236
8078	20	17,61	1,2	0,193

STOR PERDE PROFİLLER

Yuvarlak Borular

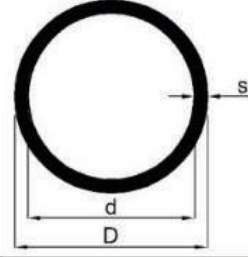

NO	D(mm)	d(mm)	s(mm)	kg /m
2401	20,5	18,5	1	0,165
8516	22,5	20,5	1	0,183
5129	24	21	1,5	0,287
8817	25	22	1,5	0,301
8302	28	26	1	0,220
6287	30	26	2	0,477
8334	34	32	1	0,268
7261	35	32,6	1,2	0,344
8145	40	30	5	1,490
3103	40	36	2	0,648
8146	50	40	5	1,915

STOR PERDE PROFİLLERİ

Yuvarlak Borular

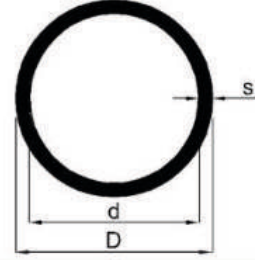

NO	D(mm)	d(mm)	s(mm)	kg / m
7129	50	47,3	1,35	0,555
3365	60	40	10	4,255
8147	60	50	5	2,341
5114	60	58,2	0,9	0,460
7256	70	66,6	1,7	0,989
8622	80	72,2	3,9	2,526
7257	100	96,7	1,65	1,381

STOR PERDE PROFİLLER

Kare Çubuklar

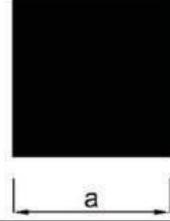

NO	a(mm)	kg /m
3370	7	0,133
5014	9,9	0,258
5021	24	1,539

STOR PERDE PROFİLLER

L Profiller

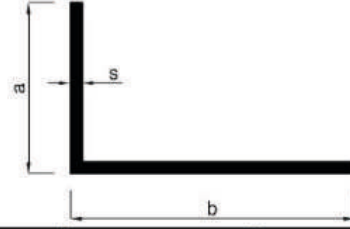

NO	a(mm)	b(mm)	s(mm)	kg /m
942	10	10	1	0,052
944	10	20	1	0,079
8185	10	25	1,5	0,136
8074	10	40	1,5	0,198
5406	15	15	1,2	0,095
519	15	15	1,5	0,117
8072	15	20	1,5	0,136
8186	15	25	1,5	0,157
945	15	30	1	0,120
5070	20	20	1	0,106
516	20	20	1,5	0,

STOR PERDE PROFİLLERİ

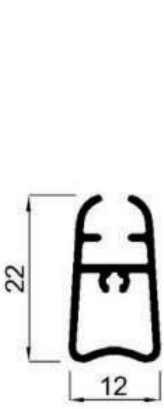

8417 - 0,163 kg/m

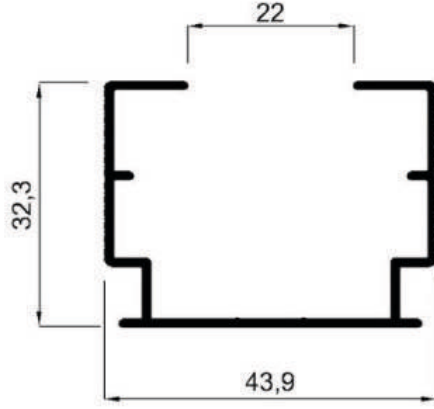

8437 - 0,347 kg/m

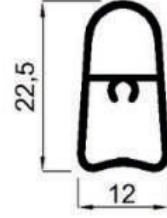

8811 - 0,155 kg/m

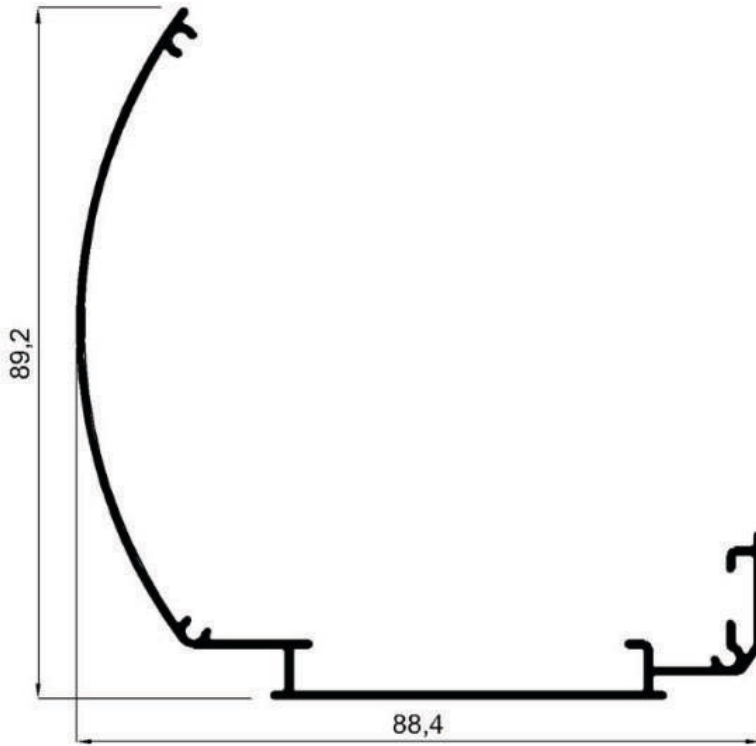

8131 - 0,543 kg/m

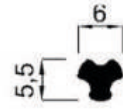

2412 - 0,052 kg/m

STOR PERDE PROFİLLERİ

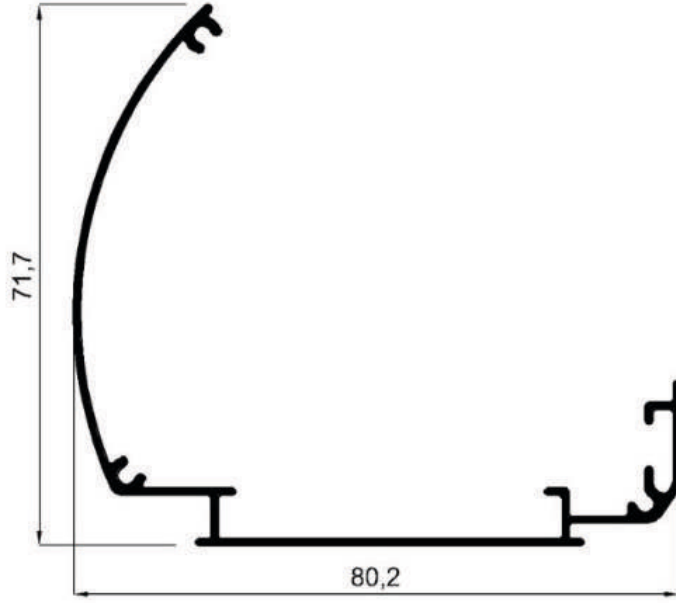

8000 - 0,507 kg/m

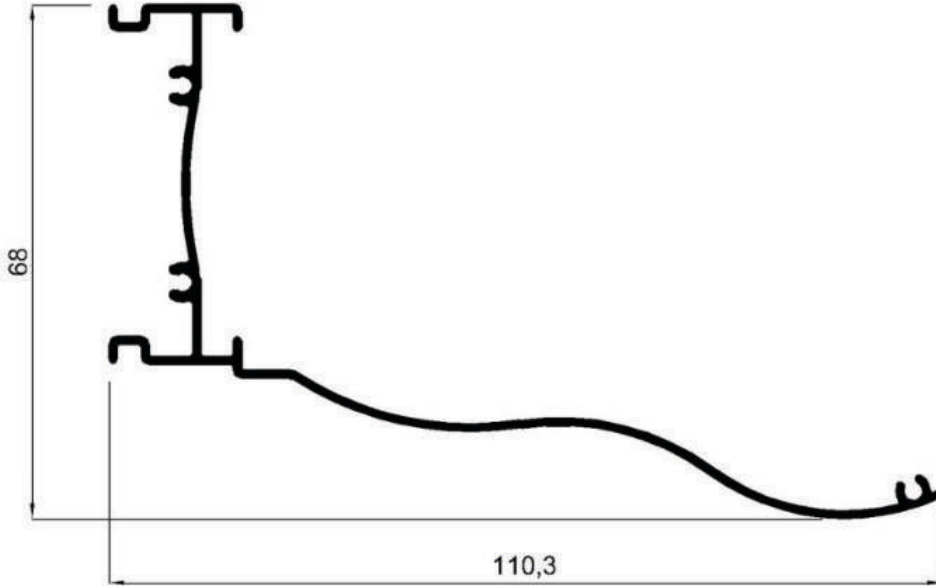

8442 - 0,561 kg/m

STOR PERDE PROFİLLERİ

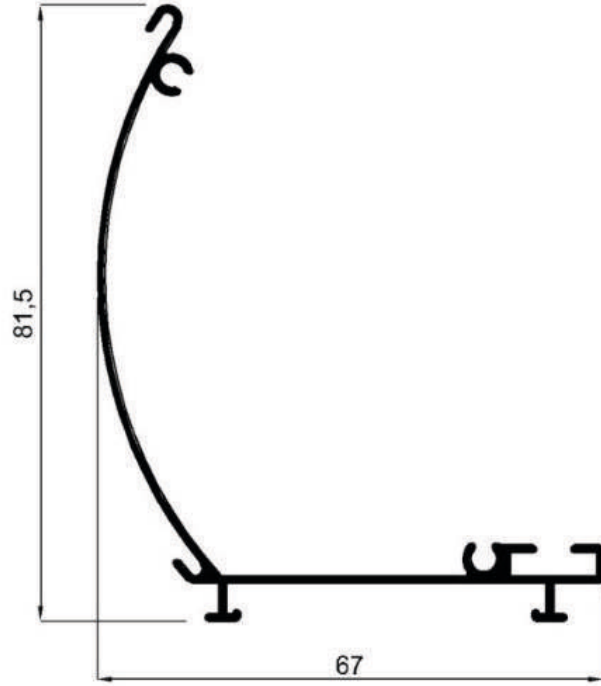

8458 - 0,502 kg/m

STOR PERDE PROFİLLERİ

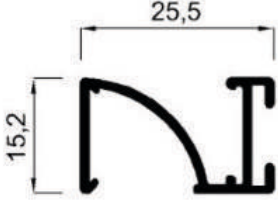

8499 - 0,204 kg/m

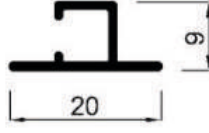

8500 - 0,097 kg/m

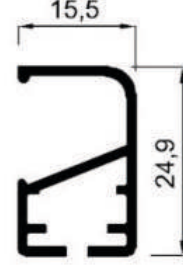

8532 - 0,222 kg/m

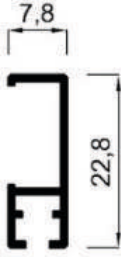

8533 - 0,108 kg/m



8534 - 0,088 kg/m

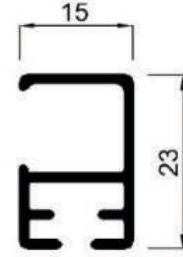

8535 - 0,226 kg/m



8544 - 0,135 kg/m

STOR PERDE PROFİLLERİ

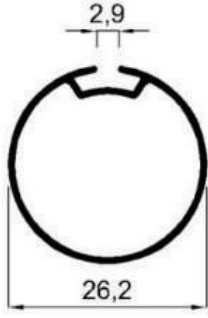

5564 - 0,171 kg/m

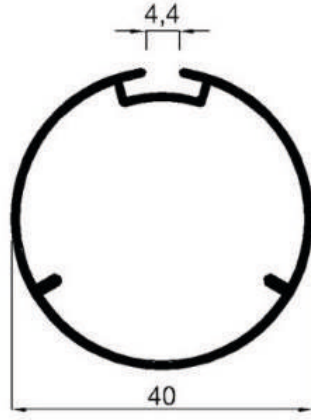

3119 - 0,390 kg/m

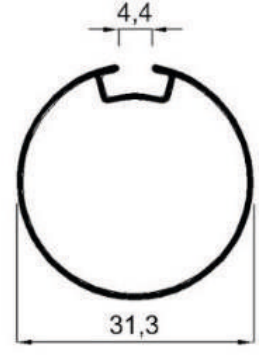

5556 - 0,250 kg/m

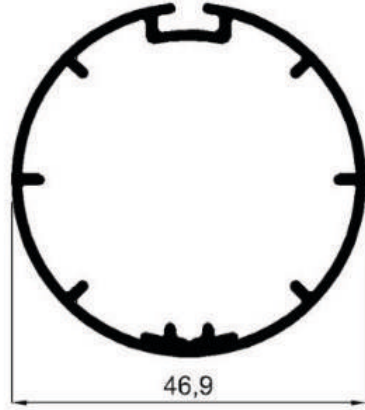

8799 - 0,631 kg/m

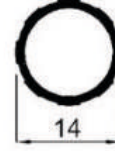

8416 - 0,098 kg/m

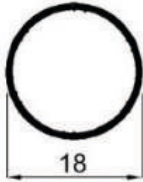

8478 - 0,107 kg/m



8012 - 0,203 kg/m



8243 - 0,144 kg/m

STOR PERDE PROFİLLERİ

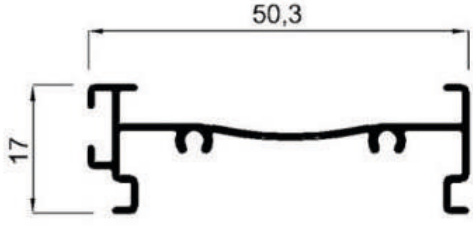

8013 - 0,234 kg/m

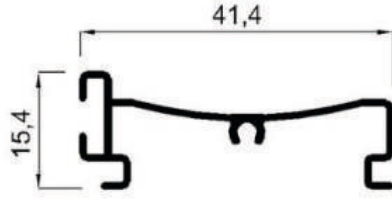

8158 - 0,182 kg/m

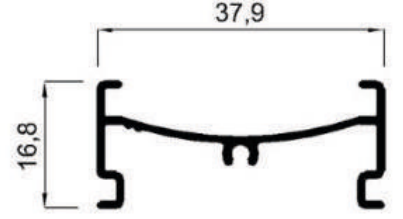

8242 - 0,198 kg/m

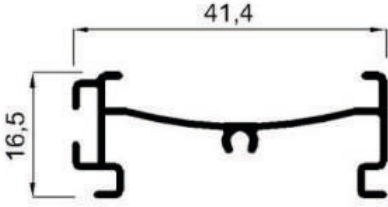

8269 - 0,206 kg/m

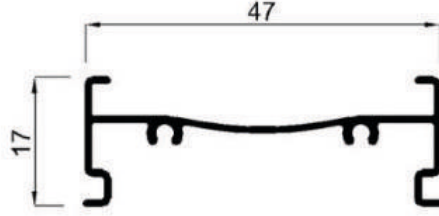

8371 - 0,206 kg/m

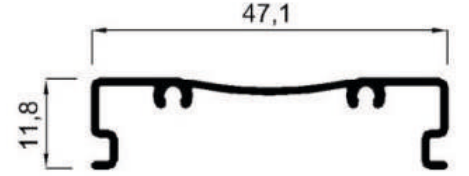

8392 - 0,207 kg/m

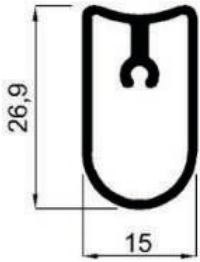

8014 - 0,244 kg/m

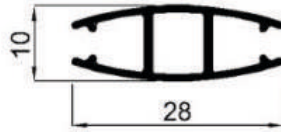

8159 - 0,182 kg/m

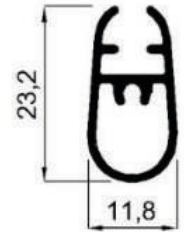

8200 - 0,181 kg/m

DANKRANT PROFİLLERİ

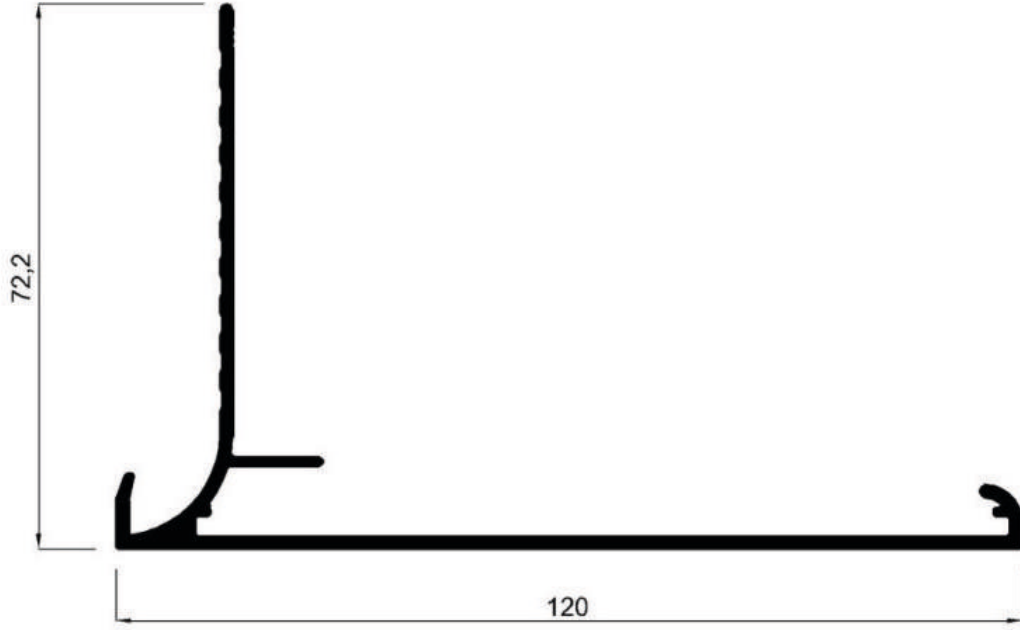

8549 - 1,017 kg/m

DANKRANT PROFİLLERİ

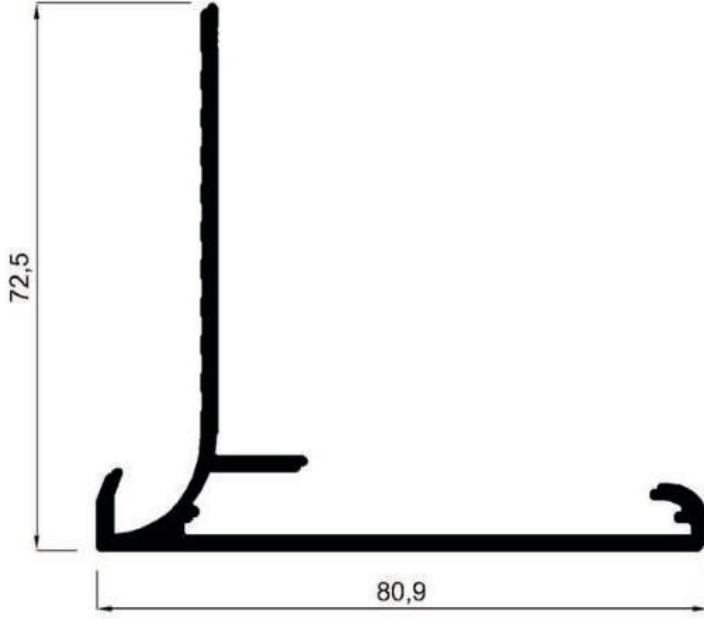

8547 - 0,623 kg/m

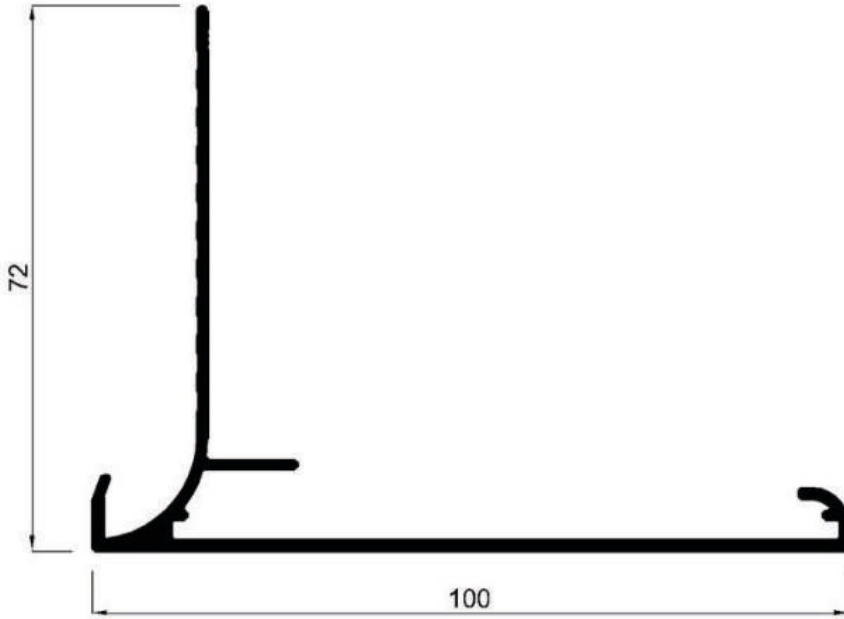

8548 - 0,829 kg/m

ÖN İKİ KULP PROFİLLERİ

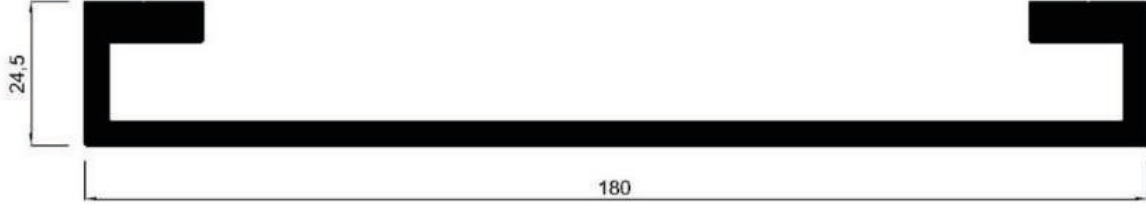

8581 - 3,001 kg/m

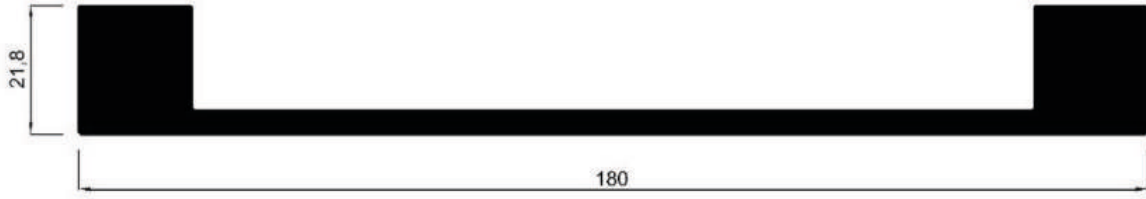

8592 - 3,784 kg/m



8706 - 0,084 kg/m

ÖN İKİ KULP PROFİLLERİ

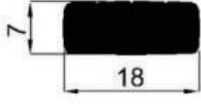

8303 - 0,328 kg/m

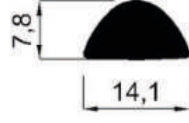

8304 - 0,217 kg/m

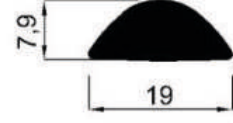

8305 - 0,293 kg/m

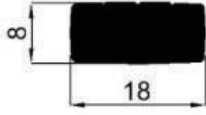

- 0,377 kg/m

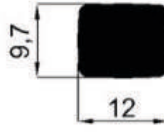

- 0,304 kg/m



- 0,415 kg/m

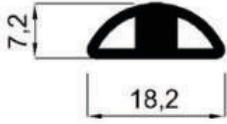

8485 - 0,189 kg/m

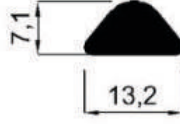

8486 - 0,176 kg/m

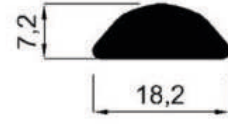

8487 - 0,262 kg/m



8488 - 0,109 kg/m

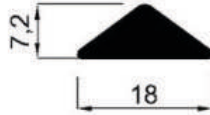

8503 - 0,198 kg/m



8555 - 0,244 kg/m

ULUYOL

Yapı Elemanları Tic.

İmalata
Hazır!

PLİSE SİNEKLİK

Tül ve Aksesuarları

Plise F1

Habibler Mah. Elmalılı Hamdi Yazır Cad.
No:57/C Kepez/Antalya

İLETİŞİM

+90 534 204 74 72

www.plisef1.com

info@plisef1.com